



Expert
Solutions
for Biopharma
Applications

BIOPHARMA
Pumps



Where Innovation Flows

MULTIPLE-USE QUATERNARY DIAPHRAGM PUMPS
SINGLE-USE QUATERNARY DIAPHRAGM PUMPS



quattroflow.com



Table of Contents:

Quattroflow™ Pumps – Overview	3
The Idea: Pumps Follow Evolution	4
Markets Served	5
Multiple-Use & Single-Use Pumps	6
Single-Use Pump Chamber Replacing System EZ-Set.	7
HT-Models with Integrated Controller	8
Lobe Pumps and Quattroflow Pumps Compared	9
Peristaltic Pumps and Quattroflow Pumps Compared	10
Accessories	12
Pump Selection Guide	13
Technical Data and Performance Charts:	
<i>Multiple-Use Pumps</i>	
• QF150S.	14
• QF1200S	15
• QF1200S-CV	16
• QF1200S-HT.	17
• QF4400S	18
• QF4400S-HT.	19
• QF5050S	20
• QF10k	21
• QF20k	22
<i>Single-Use Pumps</i>	
• QF150SU.	23
• QF1200SU	24
• QF1200SU-M	25
• QF1200SU-CV	26
• QF1200SU-HT.	27
• QF4400SU	28
• QF4400SU-HT.	29
• QF5050SU	30
• QF20kSU.	31

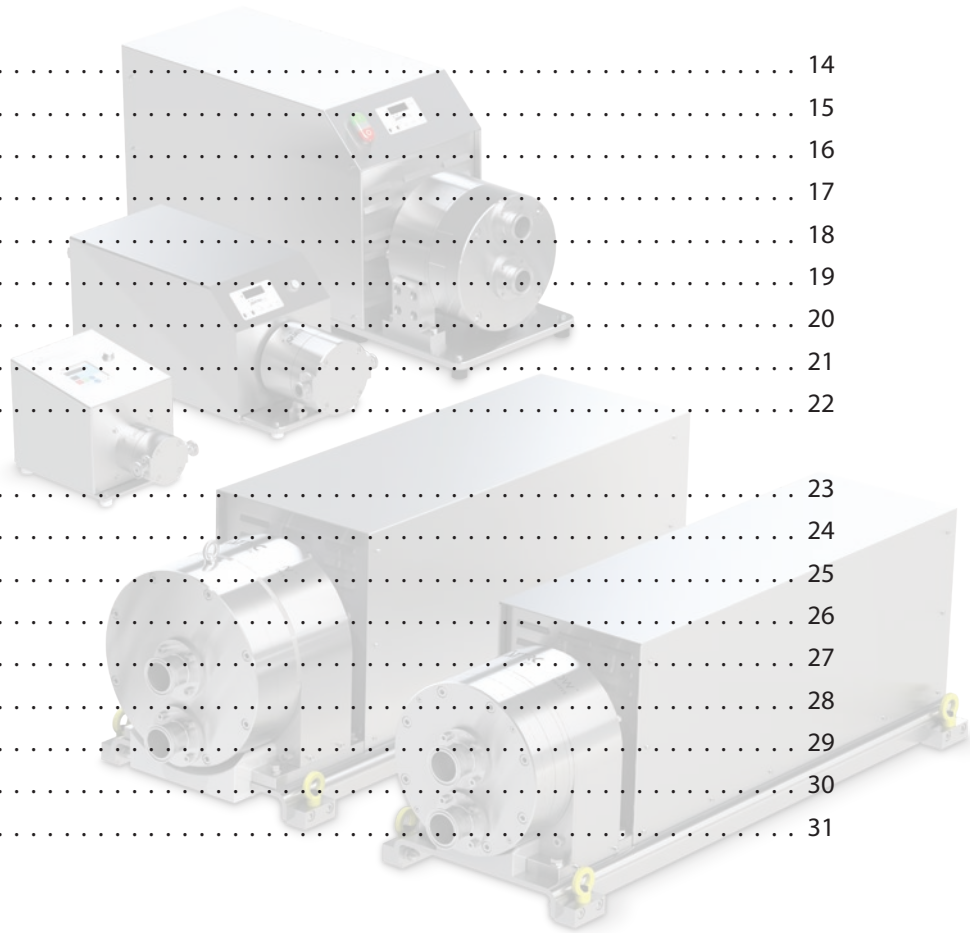

Quattroflow™ Pumps Overview

TECHNOLOGY: 4-PISTON DIAPHRAGM

Multiple-Use and Single-Use

Quaternary Diaphragm Pumps

Quattroflow multiple-use pumps have a vast array of options and flow rates to accommodate many biopharmaceutical applications. Whether your requirement is 1 lph (0.017 lpm) or 16,000 lph (267 lpm) Quattroflow has your application covered with high purity, easily cleanable, multiple use units. From OEM's and small scale automated systems, to large laboratories and crossflow systems, the QF Series provides the purity needed for the most demanding pharmaceutical and bio-technology applications.

Quattroflow single-use combines convenience with the ability to save time and money by eliminating the cost of cleaning and decontamination. Gamma-irradiated upon request, these pumps ensure the integrity of your process and production output by providing the safe, clean and reliable transfer of your high purity process fluids.



QF1200S
Multiple-Use Quaternary
Diaphragm Pump

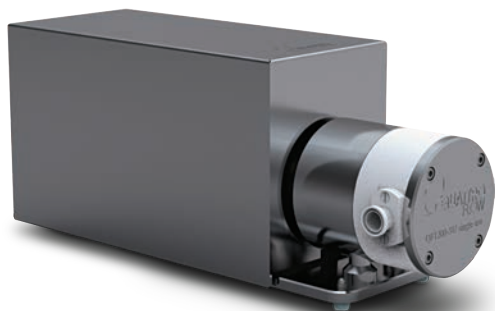

QF1200SU
Single-Use Quaternary
Diaphragm Pump

Applications and Products

- Chromatography systems
- Cross-flow systems, TFF
- Centrifuges
- Homogenizers
- Direct flow filters
- Reaction dosing
- Virus or sterile filtration
- Depth filtration
- Buffer mixing systems
- Blood plasma fractionation
- Virus cultures
- Bacterial and viral vaccines
- Cell cultures
- Cell cultures supernatants
- Enzyme solutions
- Antibodies
- Virus inactivation
- DF/MF/UF filters

Features and Benefits

- Minimal maintenance
- Minimal downtime
- Low pulsation
- Superior containment
- Variable wide flow
- Capable of dry run
- Self-priming
- Cleanable outer surface
- Linear turndown
- Compact design
- Low heat input
- High purity
- Minimum particle shedding
- Quiet operation
- Lower life cycle cost
- Ease of use
- Quick start-up
- Scaleable
- No cell damage
- Low shear

Technical Data

- Stainless steel materials of construction
- Single-use pump chamber: Solid polypropylene or injection-molded polyethylene
- Valves: EPDM
- Diaphragm: TPE (EPDM/PP)

Performance Data

- Flow range: 1 lph - 16,000 lph (0.017 - 267 lpm)
- Max. discharge pressure: 6 bar (87 psi)
- Max. temperature: 130°C (266°F)

Certifications & Associations



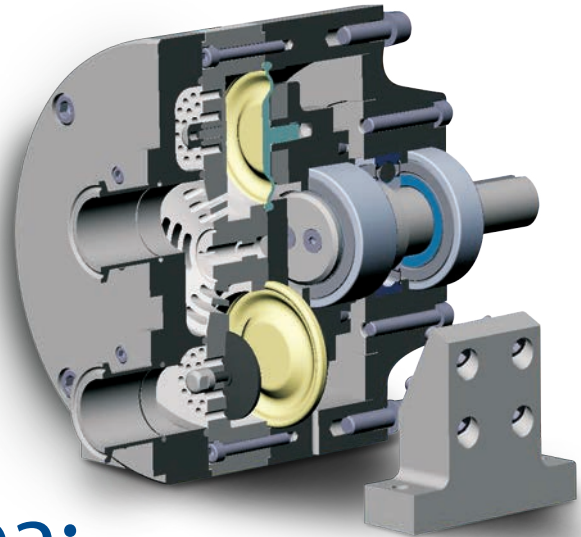

The Idea: Pump Follows Evolution

How does a pump have to be designed to convey extremely delicate biologically active molecules? The solution is in nature itself!

Millions of years of evolution developed the perfect device to pump blood that contains albumin, gamma globulins, clotting factors and cells. It is the heart!

The Quattroflow displacement pump is based on this principle. The 4-piston (quaternary) diaphragm technology enables a gentle pumping through soft "heartbeats". Each stroke of the four diaphragms is generated by an eccentric shaft, which is connected to the electric motor.

The method of operation of Quattroflow pumps allows them to gently, safely and securely convey aqueous solutions and biologic products that are sensitive to shear force with minimal impact. The four-piston design does not require a mechanical seal or wetted rotating parts, ensuring total product containment without abrasion and minimum particle generation. Additionally, the four-piston pumping principle enables risk-free dry-running, low pulsation, self-priming and a high turn-down ratio.

Markets Served

BIOPHARMACEUTICAL:

Quattroflow™ develops and manufactures single-use and multiple-use Quaternary (Four-Piston) Diaphragm Pumps for critical applications in the biopharmaceutical industry. This technology is CIP/SIP capable and offers disposable solutions that increase flexibility, reduce down-time, eliminate costs of cleaning validation, and risks of cross-contamination.

Quattroflow pumps can be found in all areas of biologic manufacturing such as cross-flow filtration systems, chromatography, and centrifuges. Quattroflow ensures safety, efficiency and reliability for handling biologics such as plasma products, therapeutic proteins, monoclonal antibodies, vaccines, and other high value products.

Typical Applications and Products Handled:

- Chromatography systems
- Cross-flow systems, TFF
- Centrifuges
- Homogenizers
- Direct flow filters
- Reaction dosing
- Virus or sterile filtration
- Depth filtration
- Buffer mixing systems
- Blood plasma fractionation
- Virus cultures
- Bacterial and viral vaccines
- Cell cultures
- Cell cultures supernatants
- Enzyme solutions
- Antibodies
- Virus inactivation

Quattroflow Pumps in the Up- and Downstream Processing of Monoclonal Antibodies

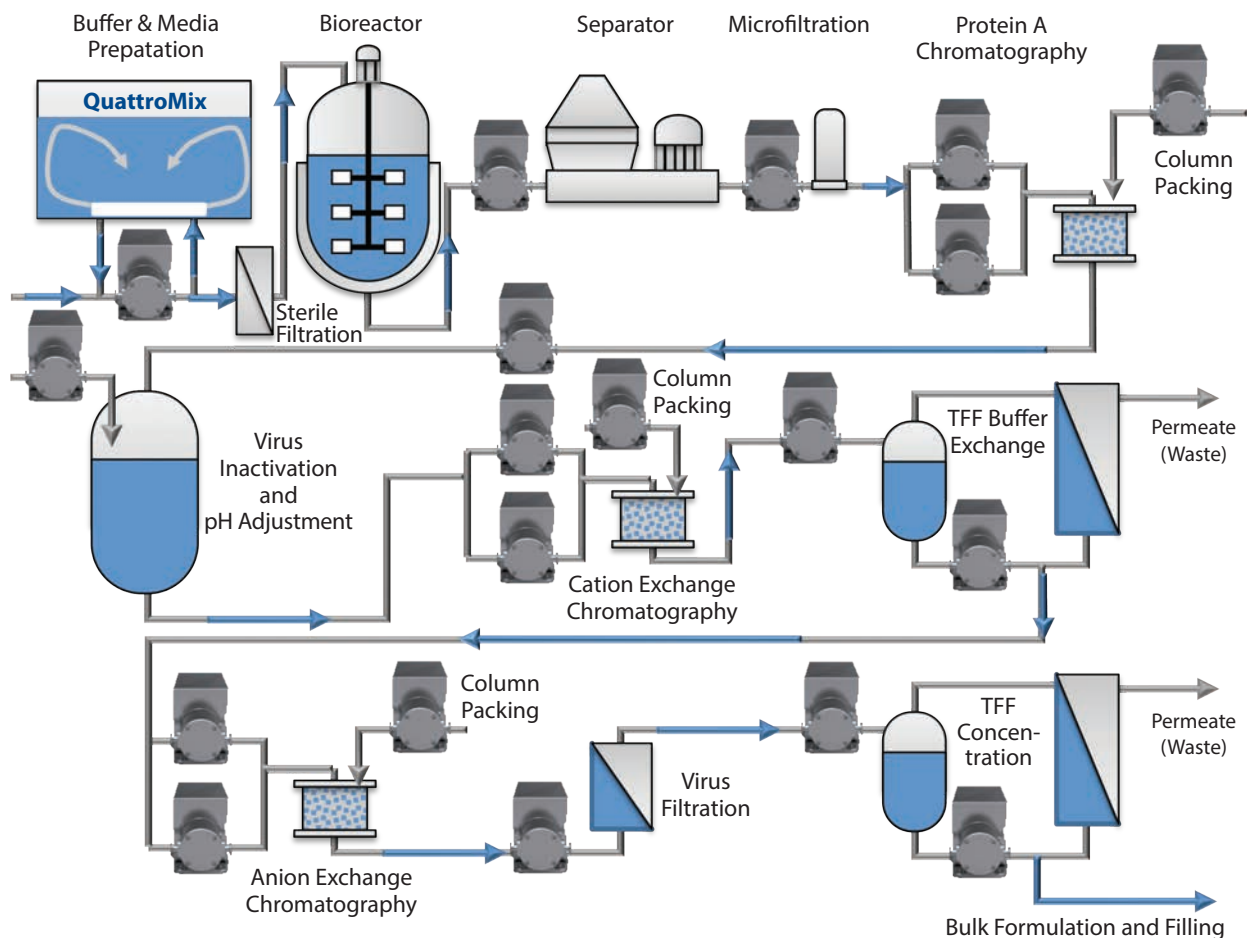



Multiple-Use & Single-Use Pumps

Quattroflow pumps are available in two variations: Cleanable Multiple-Use and the increasingly popular Single-Use

Multiple-Use Pumps:

Quattroflow stainless-steel Multiple-Use pumps deliver the highest level of purity, containment and, perhaps most important, cleanability in biopharmaceutical-manufacturing operations, from simple product transfer to critical and demanding filtration and chromatography applications. These pumps are suitable for clean-in-place/steaming-in-place (CIP/SIP) operations, as well as offering autoclave capability. The 10k pump size has a new pump chamber design (patent pending) with excellent drainability to maximize product recovery.



QF10k
Multiple-Use Quaternary
Diaphragm Pump

Single-Use Pumps:

Quattroflow Single-Use pumps have a disposable wetted pump chamber constructed of solid polypropylene (PP) or injection-molded polyethylene (PE) that can be replaced as a complete unit. The simple disposability of the pump chamber saves time and money by eliminating cleaning validation, sterilization and product cross-contamination. Single-use pumps are critical to reduce equipment turnaround times in the development biosimilar processes. In general, multi-product facilities are the typical field of application of the single-use pumps (e.g. process development, production of clinical reference samples, contract manufacturing), helping to increase operational efficiencies.



QF1200SU-HT
Single-Use Quaternary
Diaphragm Pump



PALL Allegro™ Single-Use Tangential Flow Filtration System™ using a Quattroflow QF1200SU as recirculation pump.



PALL Allegro™ MVP Single-Use System™ also with a Quattroflow QF1200SU pump, for different applications like virus filtration, sterile filtration, membrane chromatography, etc.

Images supplied courtesy of Pall Corporation



Quattroflow EZ-Set

Faster Replacement of Single-Use Pump Chambers

With the EZ-Set, you can change your Single-Use pump chamber in 30 seconds without the use of special tools or torque wrenches. The comfortable handgrip design makes replacing the chamber so easy, even while wearing rubber gloves. EZ-Set reduces downtime between batches, allowing you to spend more time doing what is really important for your work. It's quick, it's easy, and it's safe.

- Easy installation of Single-Use pump chambers
- For Single-Use pump chamber sizes 150 and 1200 (QF150SU / QF1200SU / QF1200SU-CV / QF1200SU-HT)
- Nothing to screw in
- Easy visual guide for proper tightening, no torque wrenches needed
- Available for new pumps by adding "EZ" to the pump code
- Retrofittable on existing standard Quattroflow Single-Use pumps by replacing pump chamber, pressure plate and shaft bearing kit

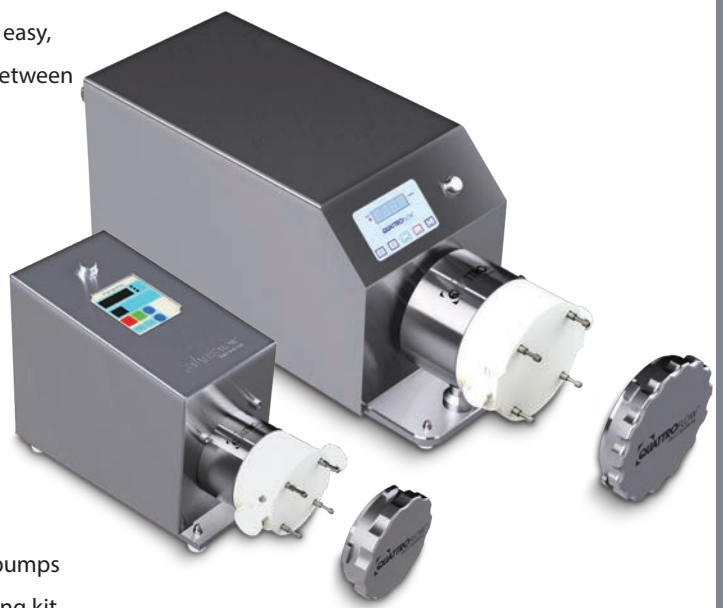

Order information for a new pump (example):

Pump	Order Number
QF150SU	QF15SU-EZ
QF1200SU	QF12SU3-EZ QF12SU5-EZ

Order information to upgrade from a standard pump to an EZ pump:

Pump	Single-Use Pump Chambers (3 units)	Pressure Plate Including Bolts	Shaft Bearing Kit
QF150SU	QF15DISPP-EZ	PQ15DISKIT-EZ	PSKITWLC155-EZ
QF1200SU	QF12DISPP-EZ	PQ12DISKIT-EZ	PSKITWLC125-EZ



Upgrade your Quattroflow™ pump with the EZ-Set pressure plate for Single-Use Quattroflow QF150 and QF1200 sizes



QF1200HT & QF4400HT

With integrated controller

High turn-down ratio & space-saving design

The Quattroflow pump sizes 1200 and 4400 are also available in a special HT version. These pumps are similar to the standard QF 1200/4400 pumps, but has integrated the pump chamber, pump drive, motor and control box into one unit. The elimination of a separate control box results in a more compact design, a smaller footprint and an easier handling.

The HT pumps offer the following features and benefits:

- “All-in-One” technology; integration of pump chamber, pump drive, motor, controller and pump housing into one unit
- Extended turndown ratio for a wider range of flow rates than the standard versions and optimal linearity
- Maximum flow rates of 1200 lph (QF1200HT) and 5000 lph (QF4400HT)
- High accuracy in controlling flow rates
- Compact design
- Keypad for manual control and display of motor speed
- Easy “Plug and Play” installation and startup with one power cable
- Flexible single-phase 110-230V power supply (QF1200HT), three phase 230V or 400V power supply (QF4400HT)
- Available with multiple-use (SS316L) and single-use (machined polypropylene) pump chamber, in addition the QF1200HT pump size can be equipped with a single-use pump chamber constructed of injection-molded polyethylene
- Clean-In-Place/Steaming-In-Place (CIP/SIP) for multiple-use pumps
- Autoclavability
- Analog input (4-20mA) as standard
- Compatible with Quattroflow PID controller



QF1200HT
Multiple-Use
& Single-Use
Quaternary
Diaphragm Pump



QF4400HT
Multiple-Use
& Single-Use
Quaternary
Diaphragm Pump



Concerned about your Lobe Pump Performance?

Quattroflow™ Pumps and Lobe Pumps Compared:

Lobe Pump Shortcomings (And Shortcomings of Gear and PD Pumps)	Quattroflow Pump Benefits
Can't satisfy all duty needs or scalability requirements	High turn-down allows for multiple flow duties and scaleup
Unable to handle both product and CIP flow duties with the same pump	High turn-down allows for consistent completion of both duties
Can't self-prime, limited suction-lift capabilities	Self-priming (even dry), wider range of suction-lift capabilities
Mechanical seals do not permit dry running	Risk-free dry running
Leakage problems with mechanical seals	Seal-less technology
High maintenance costs due to expensive mechanical seals	Seal-less design helps ensure low maintenance costs
Shock during pump shipment may lead to damaged mechanical leads	No special risks during transport
Highly skilled staff required for replacement of mechanical seals	Easy replacement of wear parts
Compromised polished fluid path because of incidental metal-to-metal contact resulting in high re-polish costs (see figure 1)	No metal-to-metal parts moving in proximity, so no loss of internal polish finish
Damage by rigid particles of undissolved salts	Less prone to damage
Large clearance required for SIP temperatures	SIP and CIP capable with no influence on performance
Low efficiency for low-viscosity products	Specially developed for low-viscosity products
Shear produced, unacceptable for shear-sensitive products	Optimized flow path for shear-sensitive products
Pump efficiency affected by component wear with time	Consistent efficiency along the pump curve independent of time
Particle generation caused by internal pump wear and mechanical seal wear can lead to product contamination	The quaternary (four-piston) technology does not require a mechanical seal or wetted rotating parts, ensuring total product containment with minimum particle generation
High power required to compensate for slip results in greater heat and shear generation for pumped products	Just 0.37 kW needed for a QF1200 pump size
Pulsation due to the high and irregular slip during rotation	Low pulsation due to quaternary diaphragm pump principle
Not suitable for single-use biopharma applications	Convertible to cleanable Multiple-Use and disposable Single-Use pump chambers

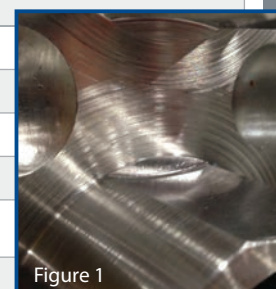
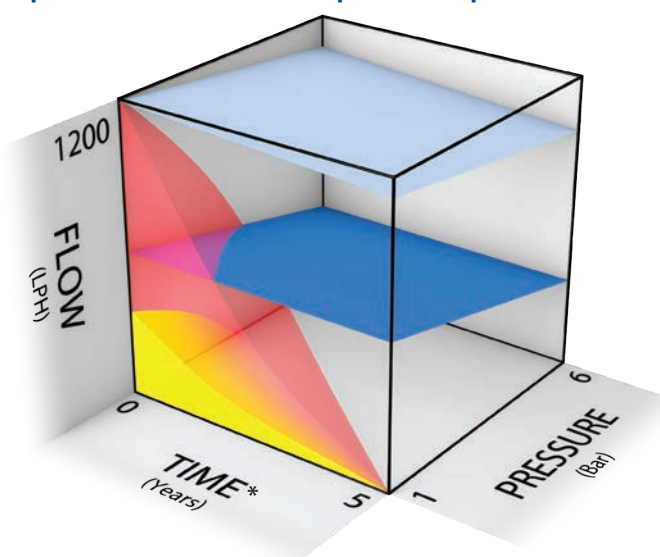

Figure 1

Performance of Quattroflow Pumps and Lobe Pumps Compared

Fixed Speed Curves

- **Quattroflow pump** at maximum speed.
Pump is only slightly influenced by pressure and wear over time.
- **The same Quattroflow pump** at half speed.
Pump is only slightly influenced by pressure and wear over time. Pump is able to match a lobe pump that slips at maximum speed.
- Larger traditional **lobe pump** slips and needs to be oversized.
- Smaller traditional **lobe pump** does not have needed flow range (turn-down) to meet flow.



* For applications that experience loss of performance from pump wear.



Quattroflow™ Pumps and Peristaltic Pumps Compared

Limitations of Peristaltic Pumps in Biopharma Production Processes

Particle generation

The major drawback of peristaltic pumps is the particle generation that is caused by the pump design. The working principle of peristaltic pumps is linked with a permanent mechanical stress of the hose material, which can be a substantial source of particles entering the fluid stream.

This abrasion may contaminate the pumped liquid and the pharmaceutical end product. As a result, the flow rate can be reduced and some pumps are not capable of reaching more than 1 bar.

Tube failure

High mechanical stress can result in tube rupture, which can lead to a catastrophic failure, costly product loss, downtime and maintenance.

Particle generation outside the hose

Spallation release may also occur outside the hose. This may compromise the fluid path but also contaminate the external clean room environment.

Flow rate consistency

With increasing operating time of the tube, mechanical stress changes the hose geometries over time and can lead to an inconsistent flow.

Pulsation

Due to their operational design, peristaltic pumps create a pulsing flow, which can adversely affect the process.

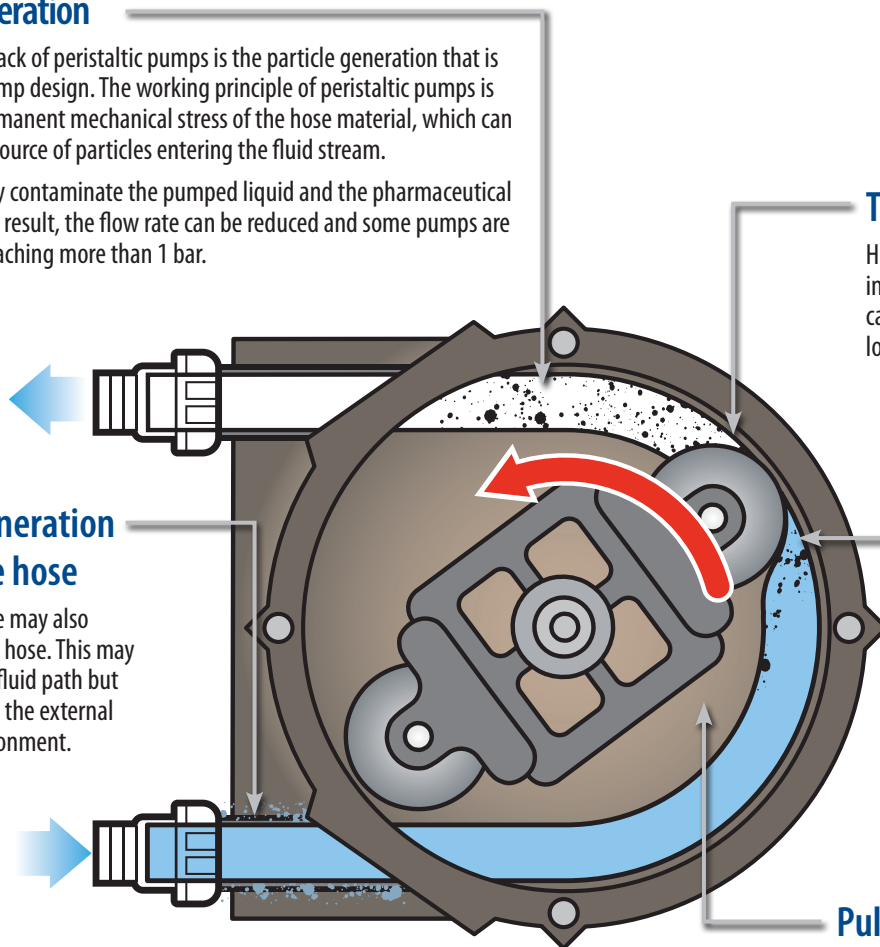

Scaling Limitations

Limited flow and pressure capabilities of peristaltic pumps means changing pump technologies as processes move from process development to cGMP creating scale up issues.



Quattroflow™ Pumps make the difference

Features and Benefits of Quattroflow Quaternary Pumps in Biopharma Production Processes



- Minimal particle generation
- Low pulsation
- Superior containment
- Consistent flow rate
- High turn-up/down ratio
- Variable and wide performance range
- Minimal component wear
- Minimal maintenance/downtime
- Quiet operation
- Low heat input
- Proof against dry running
- Self-priming
- Gamma irradiation possible



Minimal friction, shearing or temperature increase

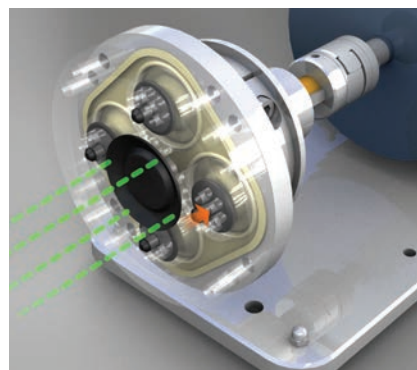

As each diaphragm expands, fluid is gently pushed through the valve

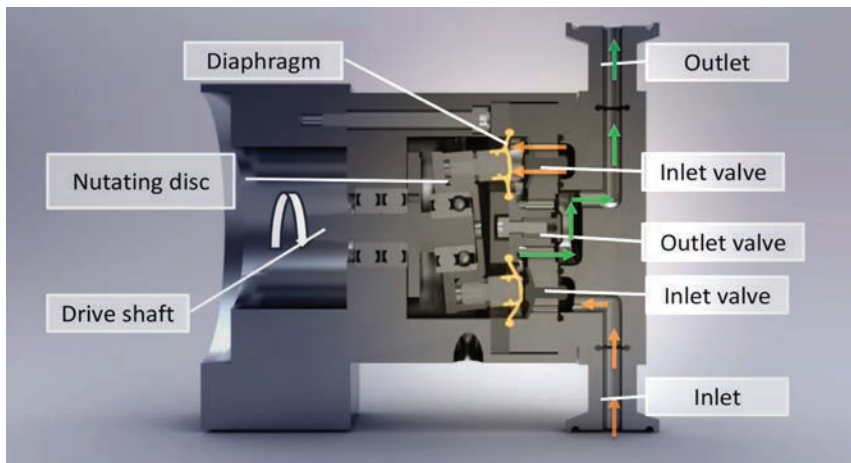

The diaphragm contracts, pulling fresh fluids from the inlet resulting in low pulsation with a high turn down ratio

Accessories

Control Box

- Variable speed controller with integrated key pad for manual speed control
- Configurable for remote speed control with 4 –20 mA analogue input
- 230V / 50 Hz or 115 V / 60 Hz for model 1200 (image left)
- 400V, 3P for models 4400/5050/20k (image right)
- Hygienic 1.4301 housing, IP 54
- Easy plug & play installation



Power Box

- Plug & Play installation
- Protects system and pump from overpressure
- Configurable pressure switch setpoint
- Reset button for pump reset
- To be used with pressure switch (also available)
- For multiple-use models only

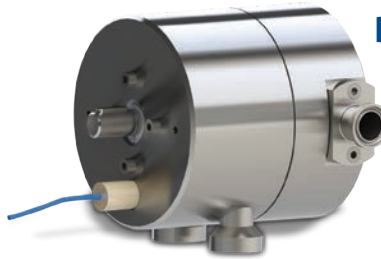

Diaphragm Sensor

- Sensor installed in ring drive unit
- Detection of all liquids
- Signal output to a controller, if diaphragm is ruptured

PID Pressure Controller

- Ideal for processes, where the Quattroflow pump should be controlled to a defined pressure or flow rate (e.g. for filtration)
- 4 –20mA input for pressure or flow sensor
- 24VDC voltage supply for sensors
- Autotune function for optimization of PID parameters
- 0 –5VDC output signal for use with QF150 or QF1200CV (requires optional analogue input), 4 –20mA for QF1200HT
- Configurable alarm setpoints for automatic shutoff of pump

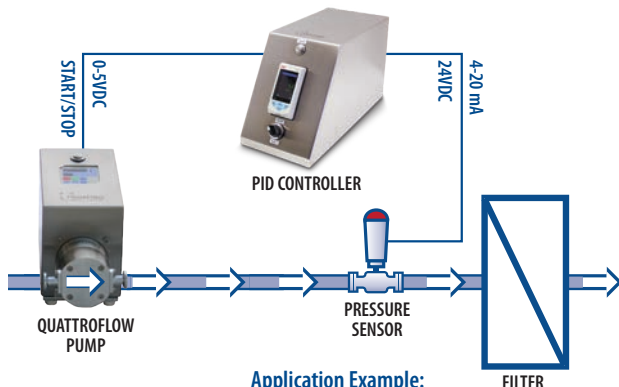

Application Example:
Pressure Control in Direct Flow Filtration

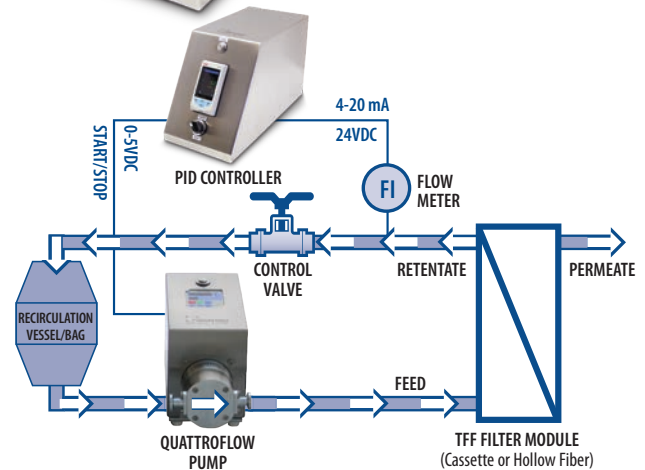









Application Example:
Cross Flow Control in Tangential Flow Filtration



Pump Selection Guide

Multiple-Use Pumps	Pump Size	Flow Range	More Data Available on Page:
	QF150S	1 – 180 lph 0.017 – 3 lpm	14
	QF1200S	10 – 1,200 lph 0.167 – 20 lpm	15
	QF1200S-CV	10 – 1,200 lph 0.167 – 20 lpm	16
	QF1200S-HT	6 – 1,200 lph 0.1 – 20 lpm	17
	QF4400S	150 – 5,000 lph 2.5 – 83 lpm	18
	QF4400S-HT	50 – 5,000 lph 0.83 – 83 lpm	19
	QF5050S	50 – 5,000 lph 0.83 – 83 lpm	20
	QF10k	500 – 10,000 lph 8.3 – 167 lpm	21
	QF20k	1,000 – 16,000 lph 16.7 – 267 lpm	22

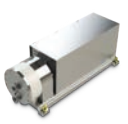
Single-Use Pumps	Pump Size	Flow Range	More Data Available on Page:
	QF150SU	1 – 180 lph 0.017 – 3 lpm	23
	QF1200SU	10 – 1,200 lph 0.167 – 20 lpm	24
	QF1200SU-M	10 – 1,200 lph 0.167 – 20 lpm	25
	QF1200SU-CV	10 – 1,200 lph 0.167 – 20 lpm	26
	QF1200SU-HT	6 – 1,200 lph 0.1 – 20 lpm	27
	QF4400SU	150 – 5,000 lph 2.5 – 83 lpm	28
	QF4400SU-HT	50 – 5,000 lph 0.83 – 83 lpm	29
	QF5050SU	50 – 5,000 lph 0.83 – 83 lpm	30
	QF20kSU	1,000 – 16,000 lph 16.7 – 267 lpm	31

All mentioned data valid for the standard pump equipment.

QF150S

Quaternary Diaphragm Pumps

Multiple-Use

- New version with 90W motor
- Integrated controller
- Digital key pad for manual operation
- Small and portable format
- Ideal for R&D and process development

Technical Data

QF150S Standard Motor		
Flow Rate Maximum:	Eccentric Shaft 5°	180 lph (3 lpm)
Flow Rate Minimum:	Eccentric Shaft 5°	1 lph (0.017 lpm)
Pressure:	Temperature of Fluid < 40° C (104° F)	6 bar (87 psi)
	Temperature of Fluid > 40° C (104° F)	4 bar (58 psi)
Maximum Temperature:	Fluid	80° C (176° F)
	CIP	90° C (194° F)
	SIP	130° C (266° F)
	Autoclave	130° C (266° F)
Suction Lift Dry at 3000 rpm:	Eccentric Shaft 5°	2 - 3 m (6.6 - 9.8 ft)
Volume Specifications:	Approximated Volume per Revolution at Free Output	1.2 ml
	Filling Volume Without Connectors	15 ml
Connection Specification (Standard):	Connectors	1/4" TC
	Position of Connectors	Inline
	Number of Flow Directions	4
Product Wetted Materials (Standard):	Pump Housing	SS316L
	Valve Plate	SS316L
	Diaphragms	TPE
	Valves	EPDM
Certificates/Proofs (Optional):	O-rings	EPDM
	Elastomere (product wetted)	USP <88> Cl. VI;
	Stainless Steel Parts (product wetted)	FDA21CFR177; BSE/TSE Safe 3.1; Surface Roughness; Ferrite Content
Motor (Standard):	Rated speed	3000 min-1
	Voltage	230 V (110 V as option)
	Power	90 W
Pump Dimension with Motor and Housing:	Length	257 mm (10.12")
	Width	164 mm (6.46")
	Height	185 mm (7.28")
Pump Weight with Motor and Housing:		9 kg (20 lb)

Other connection specifications, materials and motors available on request.



Performance Charts

Eccentric Shaft: 5°

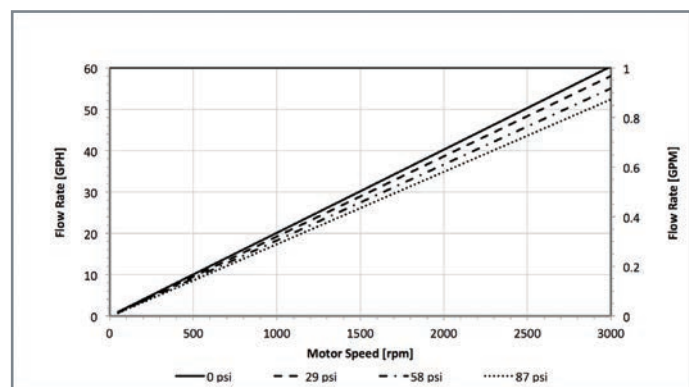
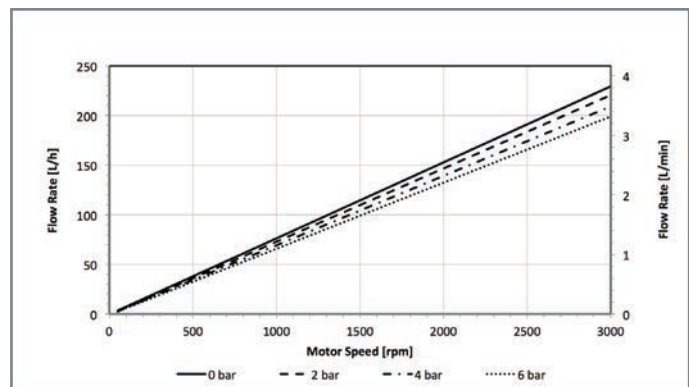

QF1200S

Quaternary Diaphragm Pumps

Multiple-Use

- Separate control box for manual operation available
- ATEX version available

Technical Data

QF1200S Standard Motor		
Flow Rate Maximum:	Eccentric Shaft 3°	800 lph (13.3 lpm)
	Eccentric Shaft 5°	1200 lph (20 lpm)
Flow Rate Minimum*:	Eccentric Shaft 3°	10 lph (0.167 lpm)
	Eccentric Shaft 5°	20 lph (0.333 lpm)
Pressure:	Temperature of Fluid < 40° C (104° F)	6 bar (87 psi)
	Temperature of Fluid > 40° C (104° F)	4 bar (58 psi)
Maximum Temperature:	Fluid	80° C (176° F)
	CIP	90° C (194° F)
	SIP	130° C (266° F)
	Autoclave	130° C (266° F)
Pump Speed Range:	rpm	30 - 2,400
Suction Lift Dry at 1800 rpm:	Eccentric Shaft 3°	2.5 - 3 m (8.2-9.8 ft)
	Eccentric Shaft 5°	4 - 4.5 m (13.1-14.7 ft)
Volume Specifications:	Approximated Volume per Revolution at Free Output	9.6 ml (5°) 5.8 ml (3°)
	Filling Volume Without Connectors	75 ml
Connection Specification (Standard):	Connectors	3/4" TC
	Position of Connectors	Inline
	Number of Flow Directions	4
Product Wetted Materials (Standard):	Pump Housing	SS316L
	Valve Plate	SS316L
	Diaphragms	TPE
	Valves	EPDM
Certificates/ Proofs (Optional):	Elastomere (product wetted)	USP <88> Cl. VI; FDA21CFR177; BSE/ TSE Safe
	Stainless Steel Parts (product wetted)	3.1; Surface Roughness; Ferrite Content
Motor (Standard):	Rated speed	1375 min-1 (50 Hz)
	Voltage	230/400 V
	Power	0.37 kW
Pump Dimension with Motor and Housing:	Length	487 mm (19.17")
	Width	159 mm (6.26")
	Height	210 mm (8.27")
Pump Weight with Motor and Housing:		24 kg (53 lb)

Other connection specifications, materials and motors available on request.
 * When using pump with control box: 20 lph (0.333 lpm) and 40 lph (0.667 lpm)

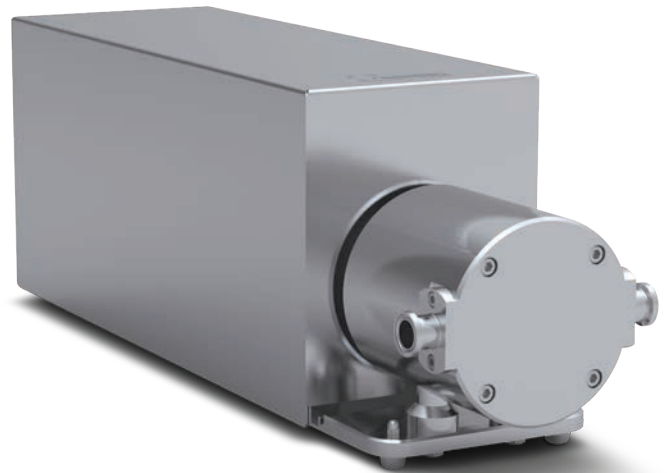

Performance Charts

Eccentric Shaft: 5°

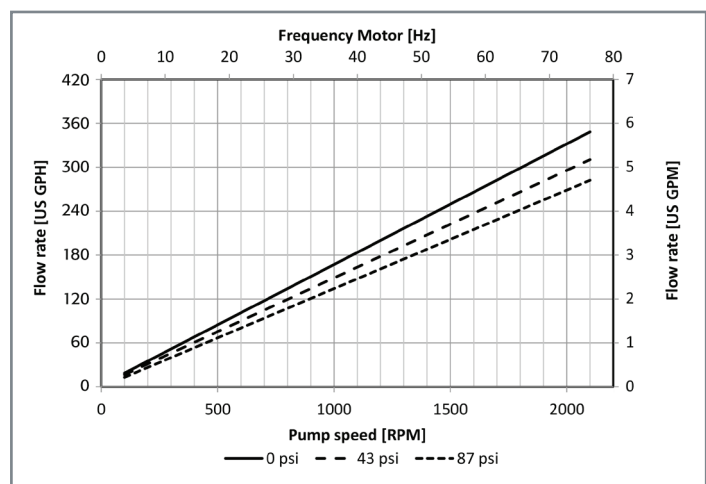
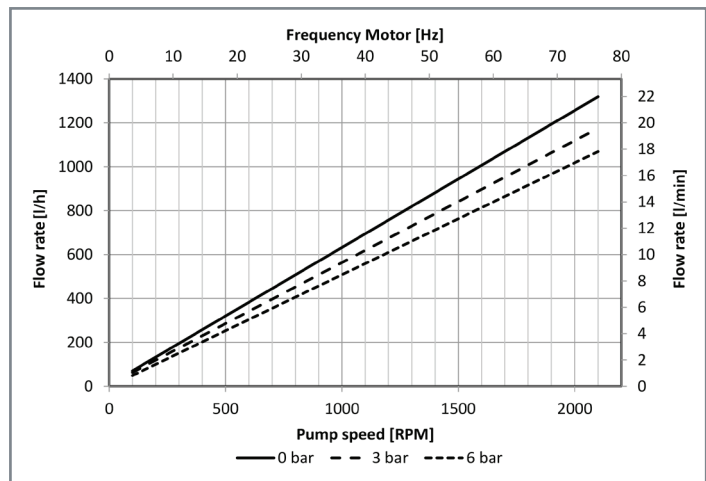

Depending on the selected motor/frequency drive combination, the motor frequency and the resulting pump speed might differ.

QF1200S-CV

Quaternary Diaphragm Pumps

Multiple-Use

- Integrated controller
- Digital key pad for manual operation
- Compact size
- 230V motor



Technical Data

QF1200S-CV Standard Motor		
Flow Rate Maximum:	Eccentric Shaft 5°	1200 lph (20 lpm)
Flow Rate Minimum:	Eccentric Shaft 5°	10 lph (0.167 lpm)
Pressure:	Temperature of Fluid < 40° C (104° F)	6 bar (87 psi)
	Temperature of Fluid > 40° C (104° F)	4 bar (58 psi)
Maximum Temperature:	Fluid	80° C (176° F)
	CIP	90° C (194° F)
	SIP	130° C (266° F)
	Autoclave	130° C (266° F)
Pump Speed Range:	rpm	10 - 2200
Suction Lift Dry at 1800 rpm:	Eccentric Shaft 5°	4 - 4.5 m (13.1-14.7 ft)
Volume Specifications:	Filling Volume Without Connectors	75 ml
	Connectors	3/4" TC
	Position of Connectors	Inline
Connection Specification (Standard):	Number of Flow Directions	4
	Pump Chamber	SS316L
Product Wetted Materials (Standard):	Valve Plate	SS316L
	Diaphragms	TPE
	Valves	EPDM
	O-rings	EPDM
Certificates/Proofs (Optional):	Elastomere (product wetted)	USP <88> Cl. VI; FDA21CFR177; BSE/TSE Safe
	Stainless Steel Parts (product wetted)	3.1; Surface Roughness; Ferrite Content
Motor:	Rated speed	2200 min ⁻¹
	Voltage	230 V
	Power	0.75 kW
Pump Dimension with Motor and Housing:	Length	487 mm (19.17")
	Width	200 mm (7.87")
	Height	210 mm (8.27")
Pump Weight with Motor and Housing:		25 kg (55 lb)

Performance Charts

Eccentric Shaft: 5°

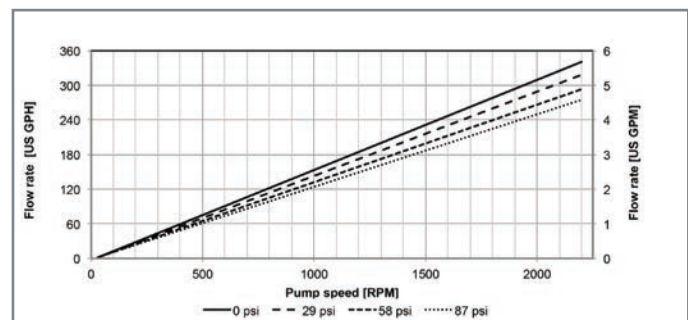
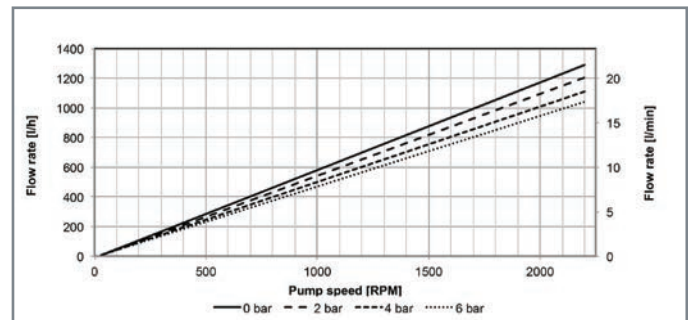

QF1200S-HT

Quaternary Diaphragm Pumps

Multiple-Use

- Integrated pump chamber, pump drive, motor and control box into one unit
- Extended turn-down ratio (200:1)
- Digital key pad for manual operation
- Compact size
- Flexible single-phase 110-230V power supply

Technical Data

QF1200S-HT Standard Motor		
Flow Rate Maximum:	Eccentric Shaft 5°	1200 lph (20 lpm)
Flow Rate Minimum:	Eccentric Shaft 5°	6 lph (0.1 lpm)
Pressure:	Temperature of Fluid < 40° C (104° F)	6 bar (87 psi)
	Temperature of Fluid > 40° C (104° F)	4 bar (58 psi)
Maximum Temperature:	Fluid	80° C (176° F)
	CIP	90° C (194° F)
	SIP	130° C (266° F)
	Autoclave	130° C (266° F)
Pump Speed Range:	rpm	10 - 2,400
Suction Lift Dry at 1800 rpm:	Eccentric Shaft 5°	4 - 4.5 m (13.1-14.7 ft)
Volume Specifications:	Filling Volume Without Connectors	75 ml
	Connection Specification (Standard):	Connectors
Connection Specification (Standard):	Position of Connectors	Inline
	Number of Flow Directions	4
	Product Wetted Materials (Standard):	Pump Chamber
Product Wetted Materials (Standard):	Valve Plate	SS316L
	Diaphragms	TPE
	Valves	EPDM
	O-rings	EPDM
Certificates/Proofs (Optional):	Elastomere (product wetted)	USP <88> Cl. VI; FDA21CFR177; BSE/TSE Safe
	Stainless Steel Parts (product wetted)	3.1; Surface Roughness; Ferrite Content
Motor:	Rated speed	2400 min-1
	Voltage	110 - 230 V
	Power	0.485 kW
Pump Dimension with Motor and Housing:	Length	489 mm (19.25")
	Width	200 mm (7.87")
	Height	220 mm (8.66")
Pump Weight with Motor and Housing:		25 kg (55 lb)



Performance Charts

Eccentric Shaft: 5°

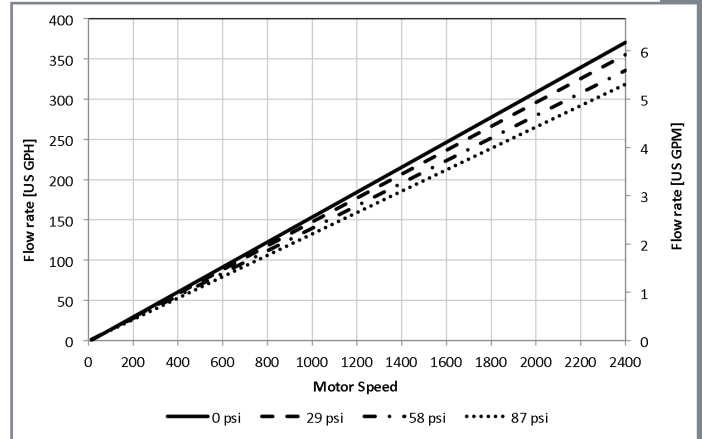
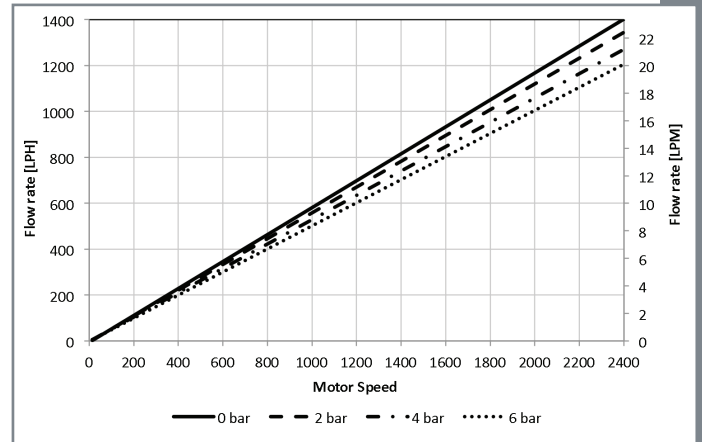

QF4400S

Quaternary Diaphragm Pumps

Multiple-Use

- Separate control box for manual operation available
- ATEX version available

Technical Data

QF4400S Standard Motor		
Flow Rate Maximum:	Eccentric Shaft 6°	5000 lph (83 lpm)
Flow Rate Minimum:	Eccentric Shaft 6°	150 lph (2.5 lpm)
Pressure:	Temperature of Fluid < 40° C (104° F)	6 bar (87 psi)
	Temperature of Fluid > 40° C (104° F)	4 bar (58 psi)
Maximum Temperature:	Fluid	80° C (176° F)
	CIP	90° C (194° F)
	SIP	130° C (266° F)*
	Autoclave	130° C (266° F)*
Suction Lift Dry at 1200 rpm:	Eccentric Shaft 6°	4 - 4.5 m (13.1-14.7 ft)
Volume Specifications:	Approximated Volume per Revolution at Free Output	95 ml
	Filling Volume Without Connectors	820 ml
Connection Specification (Standard):	Connectors	1.5" TC
	Position of Connectors	Front
Product Wetted Materials (Standard):	Pump Housing	SS316L
	Valve Plate	SS316L or PP
	Diaphragms	TPE
	Valves	EPDM/SS316L
Certificates/ Proofs (Optional):	Elastomere (product wetted)	USP <88> Cl. VI; FDA21CFR177; BSE/TSE Safe
	Stainless Steel Parts (product wetted)	3.1; Surface Roughness; Ferrite Content
Motor (Standard):	Rated speed	1410 min-1 (50 Hz)
	Voltage	230/400 V
	Power	2.2 kW
Pump Dimension with Motor and Housing:	Length	852 mm (33.54")
	Width	250 mm (9.84")
	Height	333 mm (13.11")
Pump Weight with Motor and Housing:		120 kg (265 lb)

Other connection specifications, materials and motors available on request.

*With SS316L valve plate only



Performance Charts

Eccentric Shaft: 6°

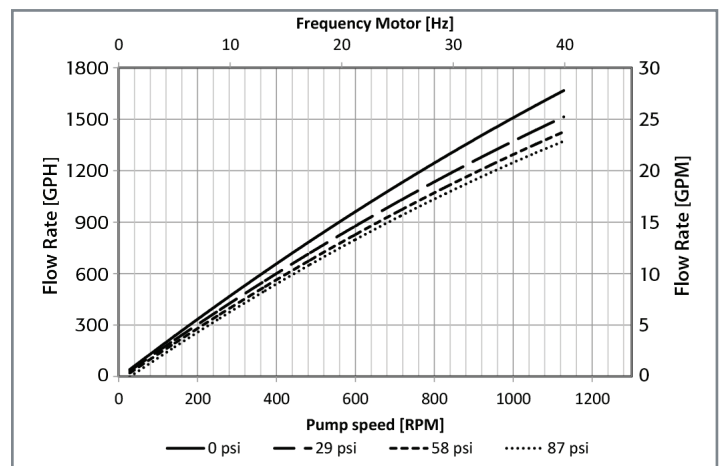
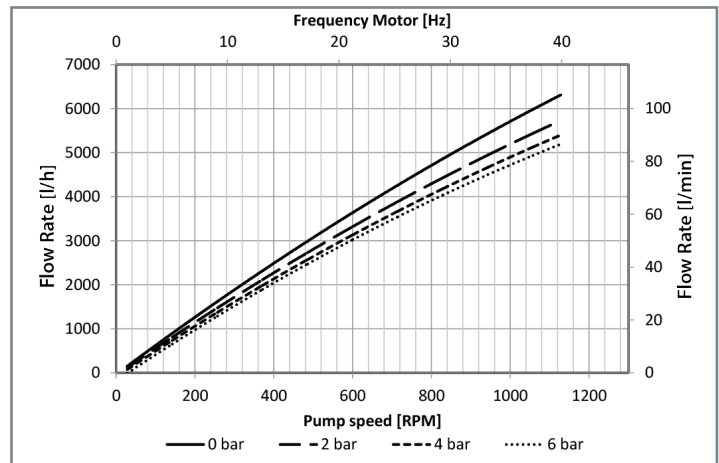

Depending on the selected motor/frequency drive combination, the motor frequency and the resulting pump speed might differ.

QF4400S-HT

Quaternary Diaphragm Pumps

Multiple-Use

- Integrated pump chamber, pump drive, motor and control box into one unit
- Extended turn-down ratio
- Compact design

Technical Data

QF4400S-HT Standard Motor		
Flow Rate Maximum:	Eccentric Shaft 6°	5000 lph (83 lpm)
Flow Rate Minimum:	Eccentric Shaft 6°	50 lph (0.83 lpm)
Pressure:	Temperature of Fluid < 40° C (104° F)	6 bar (87 psi)
	Temperature of Fluid > 40° C (104° F)	4 bar (58 psi)
Maximum Temperature:	Fluid	80° C (176° F)
	CIP	90° C (194° F)
	SIP	130° C (266° F)
	Autoclave	130° C (266° F)
Suction Lift Dry at 1200 rpm:	Eccentric Shaft 6°	4 - 4.5 m (13.1-14.7 ft)
Volume Specifications:	Approximated Volume per Revolution at Free Output	95 ml
	Filling Volume Without Connectors	820 ml
Connection Specification (Standard):	Connectors	1.5" TC
	Position of Connectors	Front
Product Wetted Materials (Standard):	Pump Housing	SS316L
	Valve Plate	SS316L
	Diaphragms	TPE
	Valves	EPDM/SS316L
Certificates/Proofs (Optional):	Elastomere (product wetted)	USP <88> Cl. VI; FDA21CFR177; BSE/TSE Safe
	Stainless Steel Parts (product wetted)	3.1; Surface Roughness; Ferrite Content
Motor (Standard):	Rated speed	1200 min ⁻¹
	Voltage	400 V*
	Power	4.0 kW
Pump Dimension with Motor and Housing:	Length	790 mm (31.10")
	Width	275 mm (10.83")
	Height	393 mm (15.47")
Pump Weight with Motor and Housing:		90 kg (198 lb)

Other connection specifications, materials and motors available on request.
 * 3 x 230V as option



Performance Charts

Eccentric Shaft: 6°

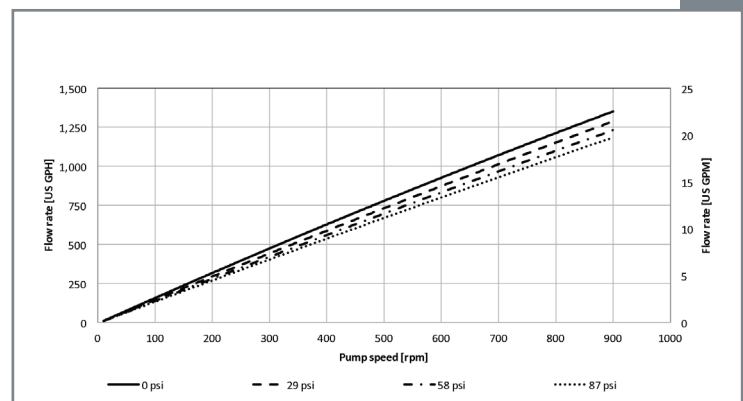
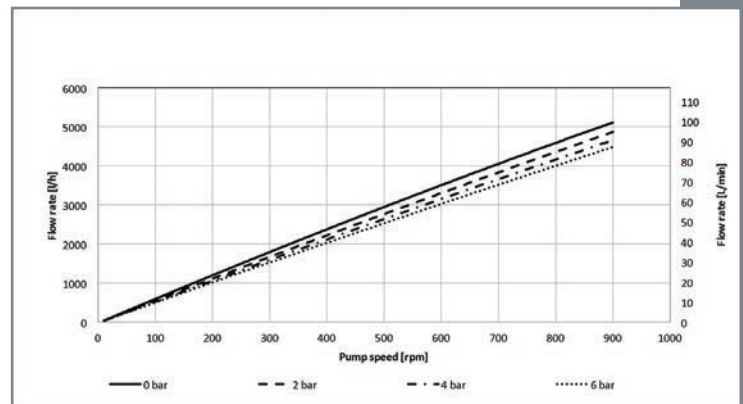

Depending on the selected motor/frequency drive combination, the motor frequency and the resulting pump speed might differ.

QF5050S

Quaternary Diaphragm Pumps

Multiple-Use

- Compact footprint
- High turn-down ratio
- Multi-option installation flexibility
- Separate control box for manual operation available

Technical Data

QF5050S Servo Motor		
Flow Rate Maximum:	Eccentric Shaft 6°	5000 lph (83 lpm)
Flow Rate Minimum:	Eccentric Shaft 6°	50 lph (0.83 lpm)
Pressure:	Temperature of Fluid < 40° C (104° F)	6 bar (87 psi)
	Temperature of Fluid > 40° C (104° F)	4 bar (58 psi)
Maximum Temperature:	Fluid	80° C (176° F)
	CIP	90° C (194° F)
	SIP	130° C (266° F)*
	Autoclave	130° C (266° F)*
Suction Lift Dry at 1200 rpm:	Eccentric Shaft 6°	4 - 4.5 m (13.1-14.7 ft)
Volume Specifications:	Approximated Volume per Revolution at Free Output	95 ml
	Filling Volume Without Connectors	820 ml
Connection Specification (Standard):	Connectors	1.5" TC
	Position of Connectors	Front
Product Wetted Materials (Standard):	Pump Housing	SS316L
	Valve Plate	SS316L or PP
	Diaphragms	TPE
	Valves	EPDM/SS316L
Certificates/ Proofs (Optional):	Elastomere (product wetted)	USP <88> Cl. VI; FDA21CFR177; BSE/TSE Safe
	Stainless Steel Parts (product wetted)	3.1; Surface Roughness; Ferrite Content
Motor (Standard):	Rated speed	3000 min ⁻¹ (2.66:1 reduction)
	Voltage	400 V
	Power	3 kW
Pump Dimension with Motor and Housing:	Length	440 mm (17.32")
	Width	325 mm (12.80")
	Height	320 mm (12.60")
Pump Weight with Motor and Housing:		66 kg (146 lb)

Other connection specifications, materials and motors available on request.
*With SS316L valve plate only

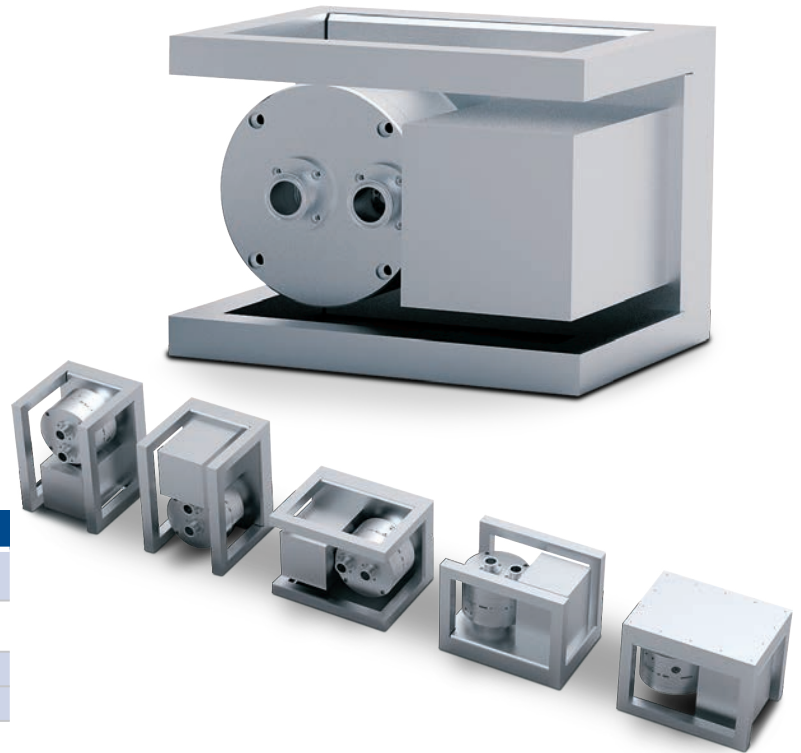

Performance Charts

Eccentric Shaft: 6°

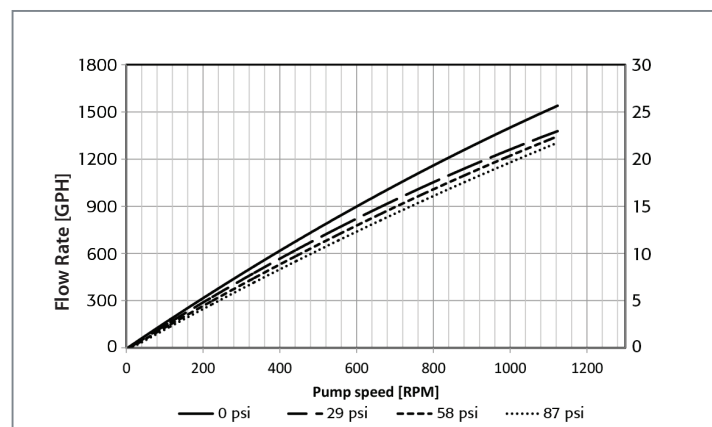
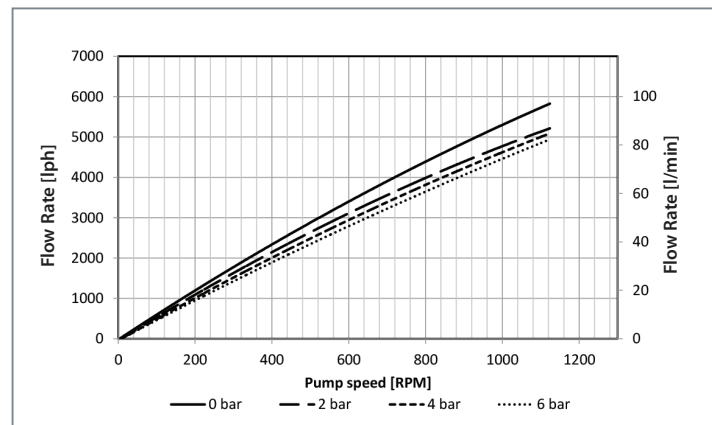

Depending on the selected motor/frequency drive combination, the motor frequency and the resulting pump speed might differ.

QF10k

Quaternary Diaphragm Pumps

Multiple-Use

- Optimized stainless steel pump chamber design (patent pending)
- Excellent drainability to maximize product recovery
- 20:1 turn-down ratio

Technical Data

QF10k Standard Motor		
Flow Rate Maximum:	Eccentric Shaft 6°	10000 lph (167 lpm)
Flow Rate Minimum:	Eccentric Shaft 6°	500 lph (8.3 lpm)
Pressure:	Temperature of Fluid < 40° C (104° F)	6 bar (87 psi)
	Temperature of Fluid > 40° C (104° F)	4 bar (58 psi)
Maximum Temperature:	Fluid	80° C (176° F)
	CIP	90° C (194° F)
	SIP	130° C (266° F)
	Autoclave	130° C (266° F)
Suction Lift Dry at 1,800 rpm:	Eccentric Shaft 6°	4 - 4.5 m (13.1-14.7 ft)
Volume Specifications:	Approximated Volume per Revolution at Free Output	194 ml
	Filling Volume Without Connectors	1,300 ml
Connection Specification (Standard):	Connectors	2" TC
	Position of Connectors	Front
Product Wetted Materials (Standard):	Pump Housing	SS316L
	Valve Plate	SS316L
	Diaphragms	TPE
	Valves	EPDM
Certificates/Proofs (Optional):	Elastomere (product wetted)	USP <88> Cl. VI; FDA21CFR177; BSE/TSE Safe
	Stainless Steel Parts (product wetted)	3.1; Surface Roughness; Ferrite Content
Motor (Standard):	Rated speed	2,894 min-1 (50 Hz)
	Voltage	230/400 V
	Power	3.0 kW
Pump Dimension with Motor and Housing:	Length	1155 mm (45.48")
	Width	437 mm (17.20")
	Height	430 mm (16.38")
Pump Weight with Motor and Housing:		185 kg (408 lb)

Other connection specifications, materials and motors available on request.

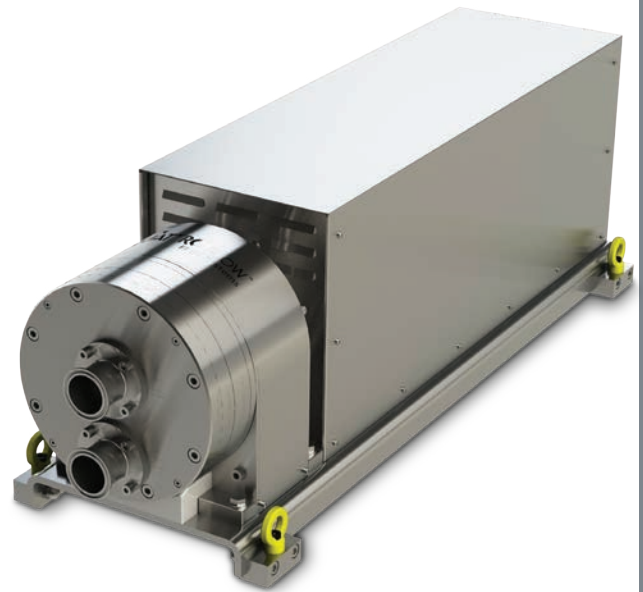

Performance Charts

Eccentric Shaft: 6°

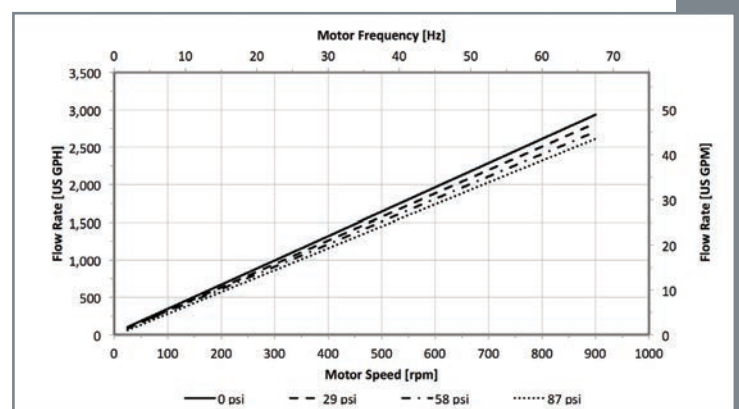
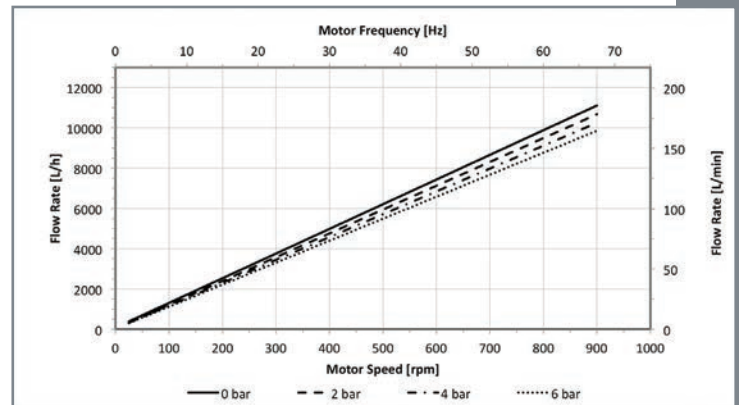

Depending on the selected motor/frequency drive combination, the motor frequency and the resulting pump speed might differ.

QF20k

Quaternary Diaphragm Pumps

Multiple-Use

- Separate control box for manual operation available
- ATEX version available



Technical Data

QF20k Standard Motor		
Flow Rate Maximum:	Eccentric Shaft 7°	16000 lph (267 lpm)
Flow Rate Minimum:	Eccentric Shaft 7°	1000 lph (16.7 lpm)
Pressure:	Temperature of Fluid < 40° C (104° F)	6 bar (87 psi)
	Temperature of Fluid > 40° C (104° F)	4 bar (58 psi)
Maximum Temperature:	Fluid	80° C (176° F)
	CIP	90° C (194° F)
	SIP	130° C (266° F)
	Autoclave	130° C (266° F)
Suction Lift Dry at 330 rpm:	Eccentric Shaft 7°	4 - 4.5 m (13.1-14.7 ft)
Volume Specifications:	Approximated Volume per Revolution at Free Output	470 ml
	Filling Volume Without Connectors	2950 ml
Connection Specification (Standard):	Connectors	2" TC
	Position of Connectors	Front
Product Wetted Materials (Standard):	Pump Housing	SS316L
	Valve Plate	SS316L
	Diaphragms	TPE
	Valves	EPDM/SS316L
Certificates/ Proofs (Optional):	Elastomere (product wetted)	USP <88> Cl. VI; FDA21CFR177; BSE/TSE Safe
	Stainless Steel Parts (product wetted)	3.1; Surface Roughness; Ferrite Content
Motor (Standard):	Rated speed	1460/474 min-1 (50 Hz)
	Voltage	230/400 V
	Power	4 kW
Pump Dimension with Motor and Housing:	Length	1152.5 mm (45.37")
	Width	400 mm (15.75")
	Height	416 mm (16.38")
Pump Weight with Motor and Housing:		217 kg (478 lb)

Other connection specifications, materials and motors available on request.

Performance Charts

Eccentric Shaft: 7°

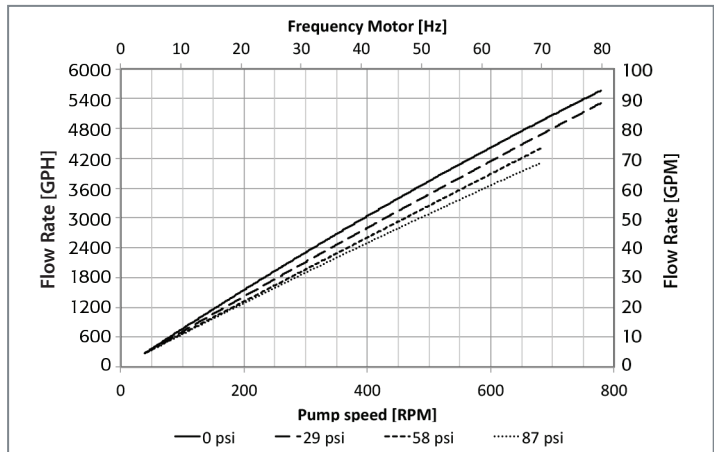
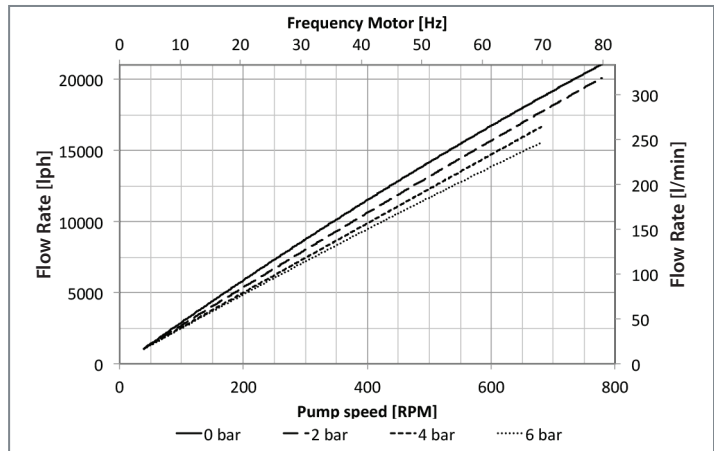

Depending on the selected motor/frequency drive combination, the motor frequency and the resulting pump speed might differ.

QF150SU

Quaternary Diaphragm Pumps

Single-Use

- New version with 90W motor
- Disposable wetted pump chamber
- Integrated controller
- Digital key pad for manual operation
- Small and portable format
- Ideal for R&D and process development

Technical Data

QF150SU Standard Motor		
Flow Rate Maximum:	Eccentric Shaft 5°	180 lph (3 lpm)
Flow Rate Minimum:	Eccentric Shaft 5°	1 lph (0.017 lpm)
Pressure:	Temperature of Fluid < 40° C (104° F)	4 bar (58 psi)
	Temperature of Fluid > 40° C (104° F)	4 bar (58 psi)
Maximum Temperature:	Fluid	60° C (140° F)
	Autoclave*	130° C (266° F)
Suction Lift Dry at 3000 rpm:	Eccentric Shaft 5°	2 - 3 m (6.6 - 9.8 ft)
Volume Specifications:	Approximated Volume per Revolution at Free Output	1.2 ml
	Filling Volume Without Connectors	15 ml
Connection Specification (Standard):	Connectors	1/4" TC
	Position of Connectors	Inline
	Number of Flow Directions	4
Product Wetted Materials (Standard):	Pump Chamber	PP
	Valve Plate	PP
	Diaphragms	TPE
	Valves	EPDM
	O-rings	EPDM
Certificates/ Proofs (Optional):	Elastomere (product wetted)	USP <88> Cl. VI; FDA21CFR177; BSE/TSE Safe; USP 87/381/661
	Rated speed	3000 min ⁻¹
Motor (Standard):	Voltage	230 V (110 V as option)
	Power	90 W
Pump Dimension with Motor and Housing:	Length	262 mm (10.31")
	Width	164 mm (6.46")
	Height	185 mm (7.28")
Pump Weight with Motor and Housing:		7.6 kg (16.8 lb)

Other connection specifications, materials and motors available on request.



Performance Charts

Eccentric Shaft: 5°

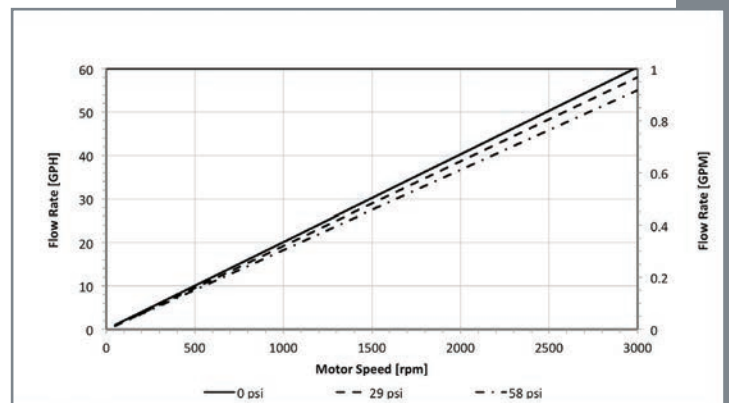
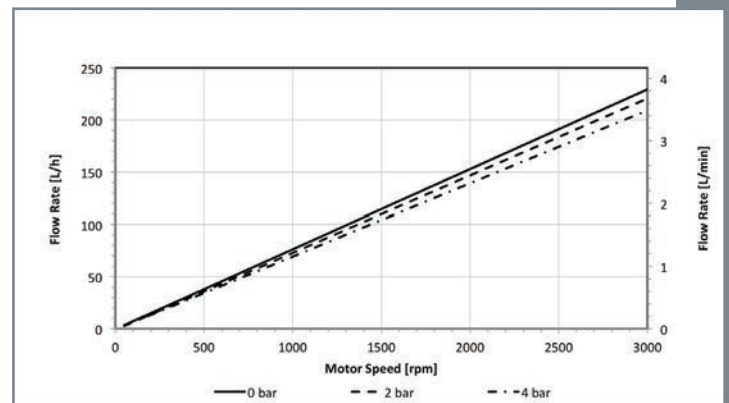

QF1200SU

Quaternary Diaphragm Pumps

Single-Use

- Disposable wetted pump chamber
- Pump chamber made of solid polypropylene
- Separate control box for manual operation available

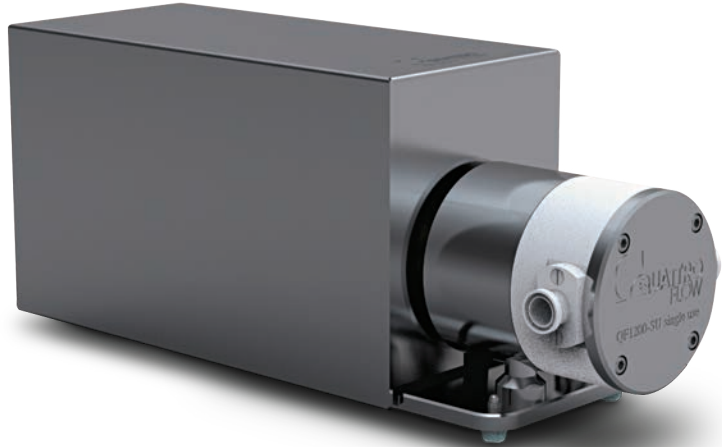

Technical Data

QF1200SU Standard Motor		
Flow Rate Maximum:	Eccentric Shaft 3°	800 lph (13.3 lpm)
	Eccentric Shaft 5°	1200 lph (20 lpm)
Flow Rate Minimum*:	Eccentric Shaft 3°	10 lph (0.167 lpm)
	Eccentric Shaft 5°	20 lph (0.333 lpm)
Pressure:	Temperature of Fluid < 40° C (104° F)	4 bar (58 psi)
	Temperature of Fluid > 40° C (104° F)	4 bar (58 psi)
Maximum Temperature:	Fluid	60° C (140° F)
	Autoclave	130° C (266° F)
Pump Speed Range:	rpm	30 - 2,400
Suction Lift Dry at 1800 rpm:	Eccentric Shaft 3°	2.5 - 3 m (8.2-9.8 ft)
	Eccentric Shaft 5°	4 - 4.5 m (13.1-14.7 ft)
Volume Specifications:	Approximated Volume per Revolution at Free Output	9.6 ml (5°) 5.8 ml (3°)
	Filling Volume Without Connectors	75 ml
Connection Specification (Standard):	Connectors	3/4" TC
	Position of Connectors	Inline
	Number of Flow Directions	4
Product Wetted Materials (Standard):	Pump Chamber	PP
	Valve Plate	PP
	Diaphragms	TPE
	Valves	EPDM
Certificates/ Proofs (Optional):	Elastomere (product wetted)	USP <88> Cl. VI; FDA21CFR177; BSE/TSE Safe; USP 87/381/661
Motor (Standard):	Rated speed	1375 min-1 (50 Hz)
	Voltage	230/400 V
	Power	0.37 kW
Pump Dimension with Motor and Housing:	Length	497 mm (19.56")
	Width	159 mm (6.26")
	Height	210 mm (8.27")
Pump Weight with Motor and Housing:		21 kg (46 lb)

Performance Charts

Eccentric Shaft: 5°

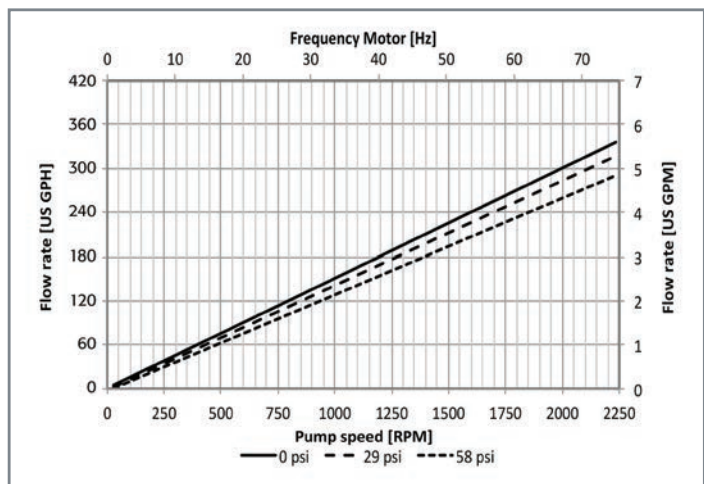
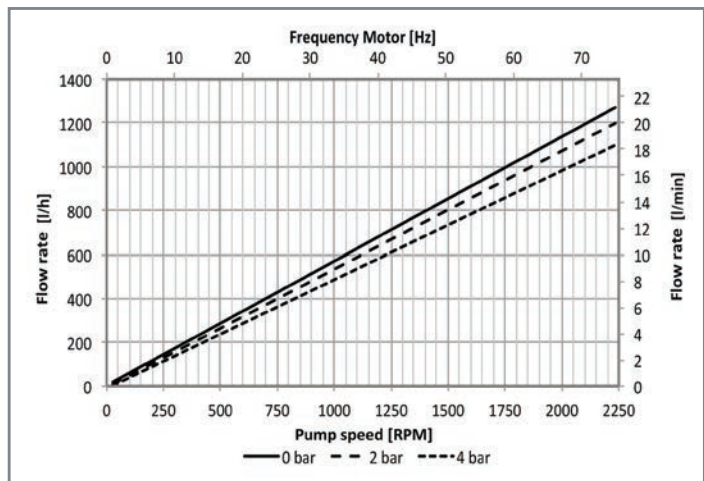

Depending on the selected motor/frequency drive combination, the motor frequency and the resulting pump speed might differ.

Other connection specifications, materials and motors available on request.

* When using pump with control box: 20 lph (0.333 lpm) and 40 lph (0.667 lpm)

QF1200SU-M

Quaternary Diaphragm Pumps

Single-Use

- Disposable wetted pump chamber
- Pump chamber made of injection-molded polyethylene
- Separate control box for manual operation available
- Front side connections

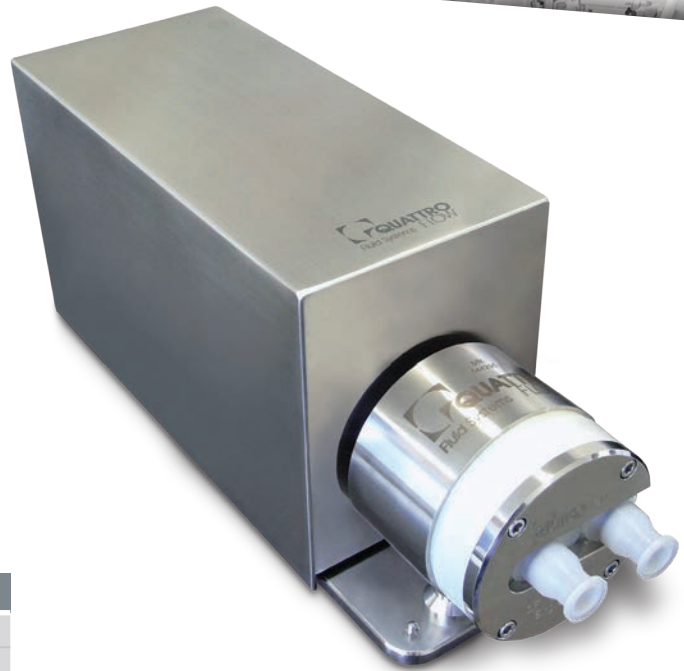

Technical Data

QF1200SU-M Standard Motor		
Flow Rate Maximum:	Eccentric Shaft 3°	800 lph (13.3 lpm)
	Eccentric Shaft 5°	1200 lph (20 lpm)
Flow Rate Minimum*:	Eccentric Shaft 3°	10 lph (0.167 lpm)
	Eccentric Shaft 5°	20 lph (0.333 lpm)
Pressure:	Temperature of Fluid < 40° C (104° F)	4 bar (58 psi)
	Temperature of Fluid > 40° C (104° F)	4 bar (58 psi)
Maximum Temperature:	Fluid	50° C (122° F)
Pump Speed Range:	rpm	30 - 2,400
Suction Lift Dry at 1800 rpm:	Eccentric Shaft 3°	2-2.5 m (6.6-8.2 ft)
	Eccentric Shaft 5°	3-3.5 m (9.8-11.5 ft)
Volume Specifications:	Approximated Volume per Revolution at Free Output	9.6 ml (5°)
	Filling Volume Without Connectors	5.8 ml (3°)
Connection Specification (Standard):	Connectors	3/4" TC
	Position of Connectors	Front
Product Wetted Materials (Standard):	Pump Chamber	PE injection molded**
	Valve Plate	PE injection molded
	Diaphragms	TPE
	Valves	EPDM
	O-rings	EPDM
Certificates/Proofs (Optional):	Elastomere (product wetted)	USP <88> Cl. VI; FDA21CFR177; BSE/TSE Safe; USP 87/381/661
Motor (Standard):	Rated speed	1375 min-1 (50 Hz)
	Voltage	230/400 V
	Power	0.37 kW
Pump Dimension with Motor and Housing:	Length	503 mm (19.8")
	Width	159 mm (6.26")
	Height	210 mm (8.27")
Pump Weight with Motor and Housing:		20 kg (44 lb)

Other connection specifications, materials and motors available on request.
 * When using pump with control box: 20 lph (0.333 lpm) and 40 lph (0.667 lpm)
 ** Connectors PP

Performance Charts

Eccentric Shaft: 5°

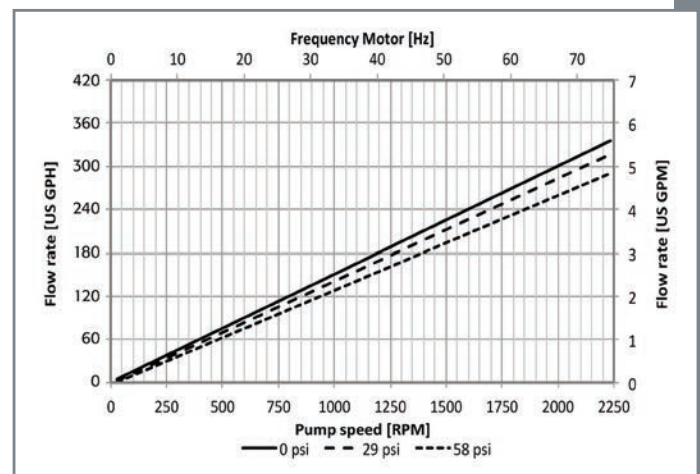
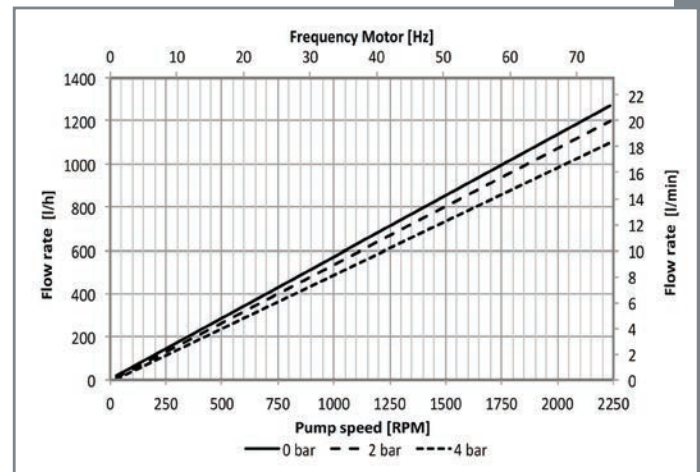

Depending on the selected motor/frequency drive combination, the motor frequency and the resulting pump speed might differ.

QF1200SU-CV

Quaternary Diaphragm Pumps Single-Use

- Disposable wetted pump chamber
- Integrated controller
- Digital key pad for manual operation
- Compact size

Technical Data

QF1200SU-CV		
Flow Rate Maximum:	Eccentric Shaft 5°	1200 lph (20 lpm)
Flow Rate Minimum:	Eccentric Shaft 5°	10 lph (0.167 lpm)
Pressure:	Temperature of Fluid < 40° C (104° F)	4 bar (58 psi)
	Temperature of Fluid > 40° C (104° F)	4 bar (58 psi)
Maximum Temperature:	Fluid	60° C (140° F)
	Autoclave	130° C (266° F)
Pump Speed Range:	rpm	10 - 2200
Suction Lift Dry at 1800 rpm:	Eccentric Shaft 5°	4 - 4.5 m (13.1-14.7 ft)
Volume Specifications:	Approximated Volume per Revolution at Free Output	9.6 ml
	Filling Volume Without Connectors	75 ml
Connection Specification (Standard):	Connectors	3/4" TC
	Position of Connectors	Inline
	Number of Flow Directions	4
Product Wetted Materials (Standard):	Pump Chamber	PP
	Valve Plate	PP
	Diaphragms	TPE
	Valves	EPDM
Certificates/ Proofs (Optional):	Elastomere (product wetted)	USP <88> Cl. VI; FDA21CFR177; BSE/TSE Safe; USP 87/381/661
Motor:	Rated speed	2200 min ⁻¹
	Voltage	230 V
	Power	0.75 kW
Pump Dimension with Motor and Housing:	Length	497 mm (19.56")
	Width	200 mm (7.87")
	Height	210 mm (8.27")
Pump Weight with Motor and Housing:		21 kg (46 lb)

Technical data for the QF1200SU-CV-M (pump chamber made of injection-molded PE) available on request.



Performance Charts Eccentric Shaft: 5°

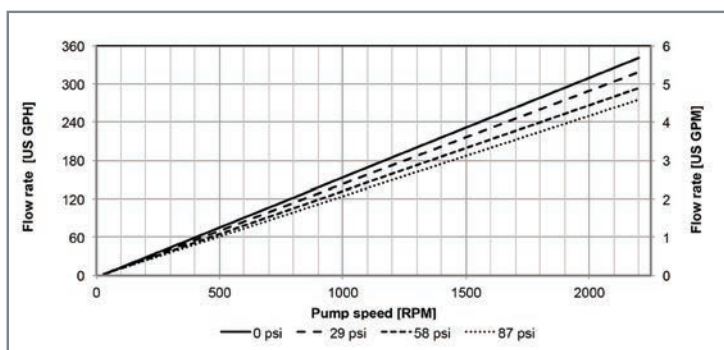
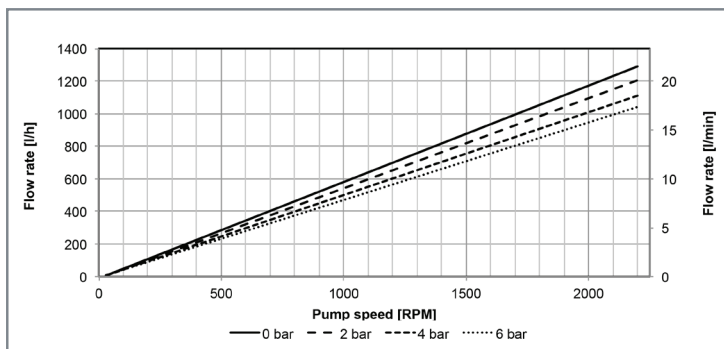

QF1200SU-HT

Quaternary Diaphragm Pumps

Single-Use

- Integrated pump chamber, pump drive, motor and control box into one unit
- Extended turn-down ratio
- Disposable plastic pump chamber

Technical Data

QF1200SU-HT Standard Motor		
Flow Rate Maximum:	Eccentric Shaft 5°	1200 lph (20 lpm)
Flow Rate Minimum:	Eccentric Shaft 5°	6 lph (0.1 lpm)
Pressure:	Temperature of Fluid < 40° C (104° F)	4 bar (58 psi)
	Temperature of Fluid > 40° C (104° F)	4 bar (58 psi)
Maximum Temperature:	Fluid	60° C (140° F)
	Autoclave	130° C (266° F)
Pump Speed Range:	rpm	10 - 2,400
Suction Lift Dry at 1800 rpm:	Eccentric Shaft 5°	4 - 4.5 m (13.1-14.7 ft)
Volume Specifications:	Approximated Volume per Revolution at Free Output	9.6 ml
	Filling Volume Without Connectors	75 ml
Connection Specification (Standard):	Connectors	3/4" TC
	Position of Connectors	Inline
	Number of Flow Directions	4
Product Wetted Materials (Standard):	Pump Chamber	PP
	Valve Plate	PP
	Diaphragms	TPE
	Valves	EPDM
Certificates/ Proofs (Optional):	Elastomere (product wetted)	USP <88> Cl. VI; FDA21CFR177; BSE/TSE Safe; USP 87/381/661
	Rated speed	2400 min ⁻¹
Motor:	Voltage	110 - 230 V
	Power	0.485 kW
Pump Dimension with Motor and Housing:	Length	499 mm (19.65")
	Width	200 mm (7.87")
	Height	220 mm (8.66")
Pump Weight with Motor and Housing:		21 kg (46 lb)



Performance Charts

Eccentric Shaft: 5°

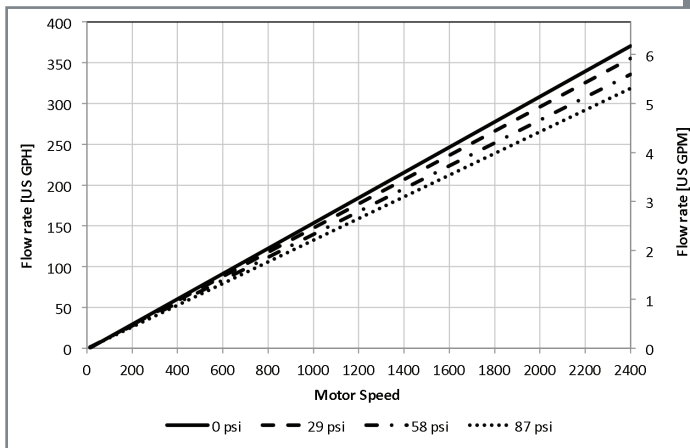
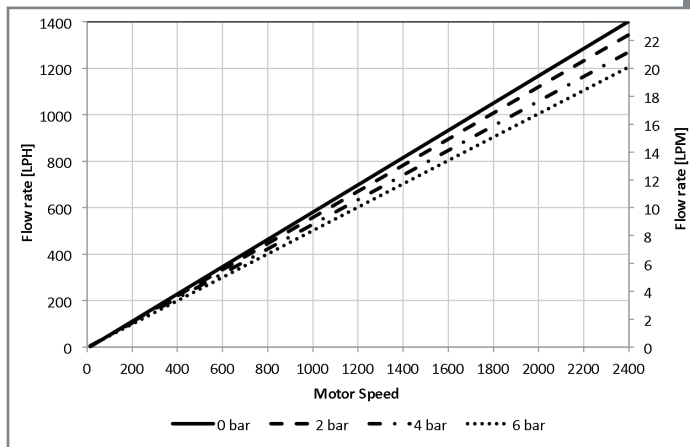

QF4400SU

Quaternary Diaphragm Pumps Single-Use

- Disposable wetted pump chamber
- Separate control box for manual operation available

Technical Data

QF4400SU Standard Motor		
Flow Rate Maximum:	Eccentric Shaft 6°	5000 lph (83 lpm)
Flow Rate Minimum:	Eccentric Shaft 6°	150 lph (2.5 lpm)
Pressure:	Temperature of Fluid < 40° C (104° F)	4 bar (58 psi)
	Temperature of Fluid > 40° C (104° F)	4 bar (58 psi)
Maximum Temperature:	Fluid	60° C (140° F)
	Autoclave	130° C (266° F)
Suction Lift Dry at 1800 rpm:	Eccentric Shaft 6°	4 - 4.5 m (13.1-14.7 ft)
Volume Specifications:	Approximated Volume per Revolution at Free Output	95 ml
	Filling Volume Without Connectors	820 ml
Connection Specification (Standard):	Connectors	1.5" TC
	Position of Connectors	Front
Product Wetted Materials (Standard):	Pump Chamber	PP
	Valve Plate	PP
	Diaphragms	TPE
	Valves	EPDM / SS316L
Certificates/ Proofs (Optional):	Elastomere (product wetted)	EPDM
		USP <88> Cl. VI; FDA21CFR177; BSE/TSE Safe; USP 87/381/661
Motor:	Rated speed	1410 min-1 (50 Hz)
	Voltage	230/400 V
	Power	2.2 kW
Pump Dimension with Motor and Housing:	Length	852 mm (33.54")
	Width	250 mm (9.84")
	Height	333 mm (13.11")
Pump Weight with Motor and Housing:		105 kg (232 lb)

Other connection specifications, materials and motors available on request.



Performance Charts Eccentric Shaft: 6°

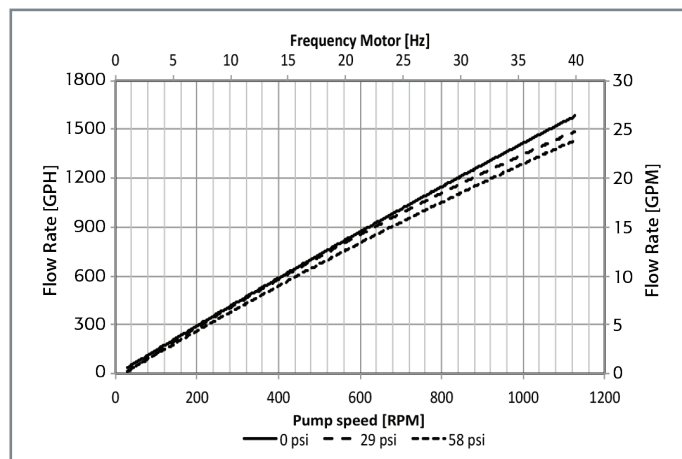
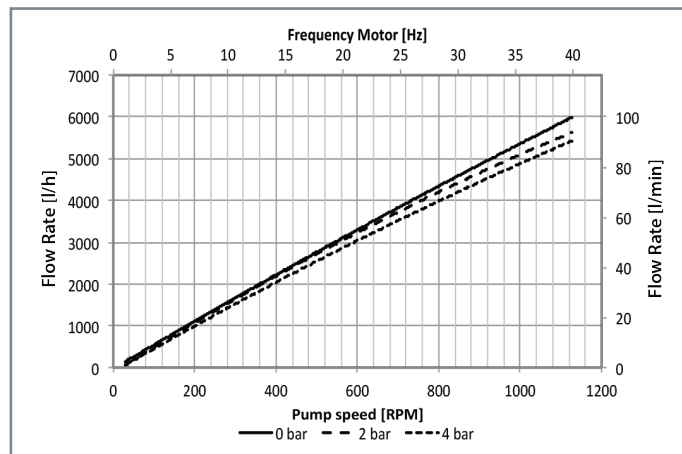

Depending on the selected motor/frequency drive combination, the motor frequency and the resulting pump speed might differ.

QF4400SU-HT

Quaternary Diaphragm Pumps

Single-Use

- Integrated pump chamber, pump drive, motor and control box into one unit
- Extended turn-down ratio
- Compact design

Technical Data

QF4400SU-HT Standard Motor		
Flow Rate Maximum:	Eccentric Shaft 6°	5000 lph (83 lpm)
Flow Rate Minimum:	Eccentric Shaft 6°	50 lph (0.83 lpm)
Pressure:	Temperature of Fluid < 40° C (104° F)	4 bar (58 psi)
	Temperature of Fluid > 40° C (104° F)	4 bar (58 psi)
Maximum Temperature:	Fluid	60° C (140° F)
	Autoclave	130° C (266° F)
Suction Lift Dry at 1800 rpm:	Eccentric Shaft 6°	4 - 4.5 m (13.1-14.7 ft)
Volume Specifications:	Approximated Volume per Revolution at Free Output	95 ml
	Filling Volume Without Connectors	820 ml
Connection Specification (Standard):	Connectors	1.5" TC
	Position of Connectors	Front
Product Wetted Materials (Standard):	Pump Chamber	PP
	Valve Plate	PP
	Diaphragms	TPE
	Valves	EPDM / SS316L
Certificates/ Proofs (Optional):	Elastomere (product wetted)	USP <88> Cl. VI; FDA21CFR177; BSE/TSE Safe; USP 87/381/661
Motor:	Rated speed	1200 min-1 (50 Hz)
	Voltage	400 V
	Power	4.0 kW
Pump Dimension with Motor and Housing:	Length	790 mm (31.10")
	Width	275 mm (10.83")
	Height	393 mm (15.47")
Pump Weight with Motor and Housing:		75 kg (165 lb)

Other connection specifications, materials and motors available on request.



Performance Charts

Eccentric Shaft: 6°

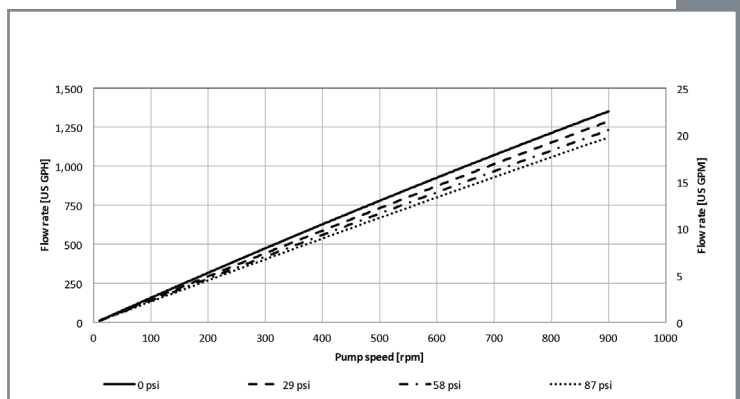
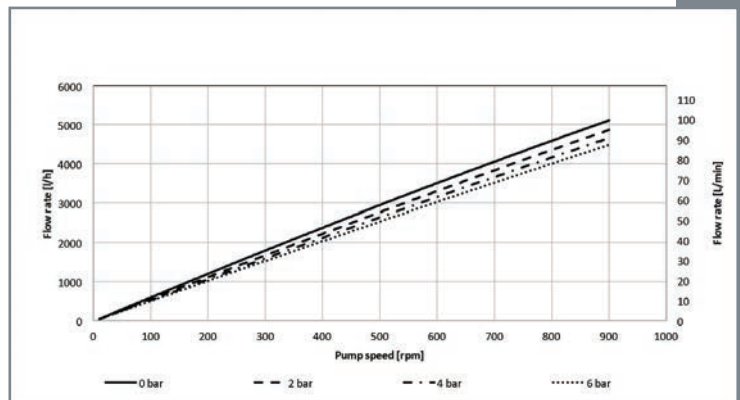

Depending on the selected motor/frequency drive combination, the motor frequency and the resulting pump speed might differ.

QF5050SU

Quaternary Diaphragm Pumps Single-Use

- Disposable wetted product chamber
- Compact footprint
- High turn-down ratio
- Multi-option installation flexibility
- Separate control box for manual operation available



Technical Data

QF5050SU Servo Motor		
Flow Rate Maximum:	Eccentric Shaft 6°	5000 lph (83 lpm)
Flow Rate Minimum:	Eccentric Shaft 6°	50 lph (0.83 lpm)
Pressure:	Temperature of Fluid < 40° C (104° F)	4 bar (58 psi)
	Temperature of Fluid > 40° C (104° F)	4 bar (58 psi)
Maximum Temperature:	Fluid	60° C (140° F)
	Autoclave	130° C (266° F)
Suction Lift Dry at 1,200 rpm:	Eccentric Shaft 6°	4 - 4.5 m (13.1-14.7 ft)
Volume Specifications:	Approximated Volume per Revolution at Free Output	95 ml
	Filling Volume Without Connectors	820 ml
Connection Specification (Standard):	Connectors	1.5" TC
	Position of Connectors	Front
Product Wetted Materials (Standard):	Pump Chamber	PP
	Valve Plate	PP
	Diaphragms	TPE
	Valves	EPDM / SS316L
Certificates/ Proofs (Optional):	Elastomere (product wetted)	USP <88> Cl. VI; FDA21CFR177; BSE/TSE Safe; USP 87/381/661
Motor:	Rated speed	3000 min ⁻¹ (2.66:1 reduction)
	Voltage	400 V
	Power	3 kW
Pump Dimension with Motor and Housing:	Length	440 mm (17.32")
	Width	325 mm (12.80")
	Height	320 mm (12.60")
Pump Weight with Motor and Housing:		51 kg (112 lb)

Other connection specifications, materials and motors available on request.

Performance Charts Eccentric Shaft: 6°

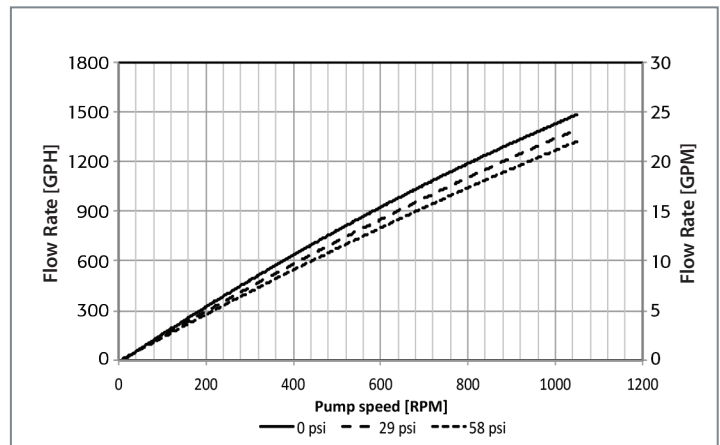
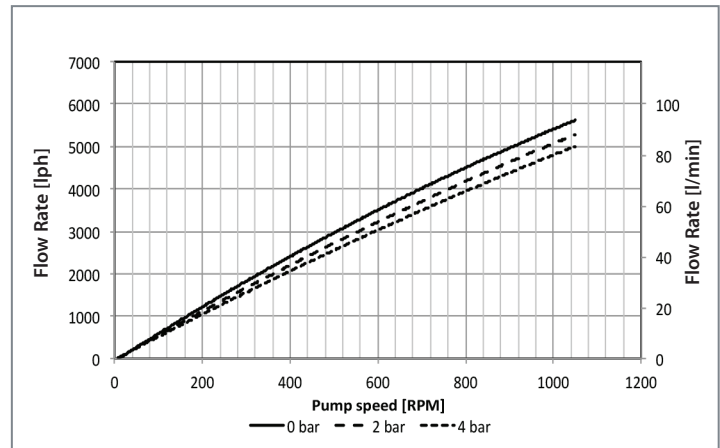

Depending on the selected motor/frequency drive combination, the motor frequency and the resulting pump speed might differ.

QF20kSU

Quaternary Diaphragm Pumps

Single-Use

- Disposable machined polypropylene pump chamber
- Easy replacement
- Installation aid

Technical Data

QF20kSU Standard Motor		
Flow Rate Maximum:	Eccentric Shaft 7°	16000 lph (267 lpm)
Flow Rate Minimum:	Eccentric Shaft 7°	1000 lph (16.7 lpm)
Pressure:	Temperature of Fluid < 40° C (104° F)	4 bar (58 psi)
	Temperature of Fluid > 40° C (104° F)	4 bar (58 psi)
Maximum Temperature:	Fluid	60° C (140° F)
Suction Lift Dry at 330 rpm:	Eccentric Shaft 7°	4 - 4.5 m (13.1-14.7 ft)
Volume Specifications:	Approximated Volume per Revolution at Free Output	470 ml
	Filling Volume Without Connectors	2950 ml
Connection Specification (Standard):	Connectors	2" TC
	Position of Connectors	Front
Product Wetted Materials (Standard):	Pump Housing	PP
	Valve Plate	PP
	Diaphragms	TPE
	Valves	EPDM/SS316L
Certificates/ Proofs (Optional):	Elastomere (product wetted)	USP <88> Cl. VI; FDA21CFR177; BSE/TSE Safe; USP 87/381/661
		Rated speed
Motor (Standard):	Voltage	230/400 V
	Power	4 kW
Pump Dimension with Motor and Housing:	Length	1152.5 mm (45.37")
	Width	400 mm (15.75")
	Height	416 mm (16.38")
Pump Weight with Motor and Housing:		190 kg (419 lb)

Other connection specifications, materials and motors available on request.

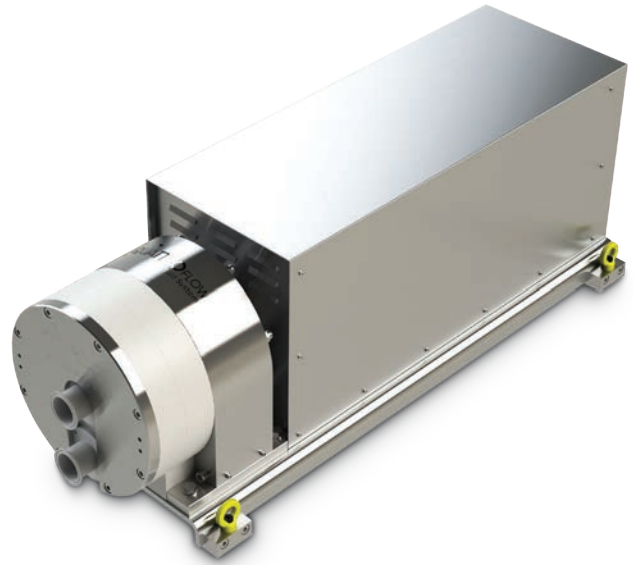

Performance Charts

Eccentric Shaft: 7°

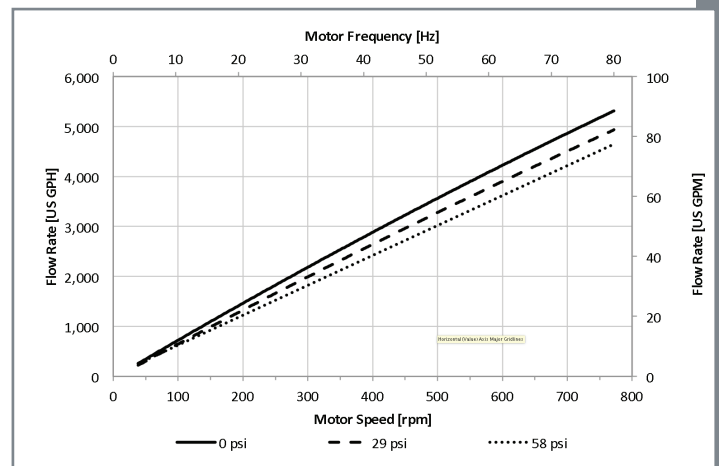
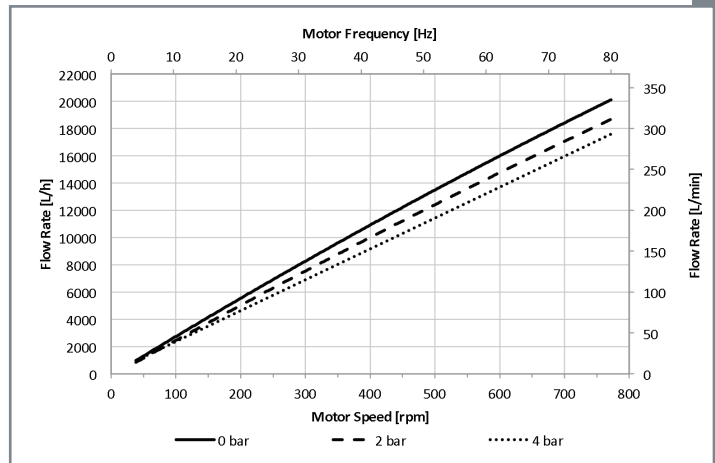

Depending on the selected motor/frequency drive combination, the motor frequency and the resulting pump speed might differ.



PSG Germany GmbH
Hochstraße 150-152
47228 Duisburg, Germany
Tel: +49 (2065) 89205-0
Fax: +49 (2065) 89205-40
psg-germany@psgdover.com
quattroflow.com

Where Innovation Flows



PSG reserves the right to modify the information and illustrations contained in this document without prior notice. This is a non-contractual document. 09-2020

Authorized PSG Partner:

Copyright ©2020 PSG, a Dover company

QTF-10100-C-03-A4